

User Manual

Revision v1.1 Oct. 2010

Mobile Computer

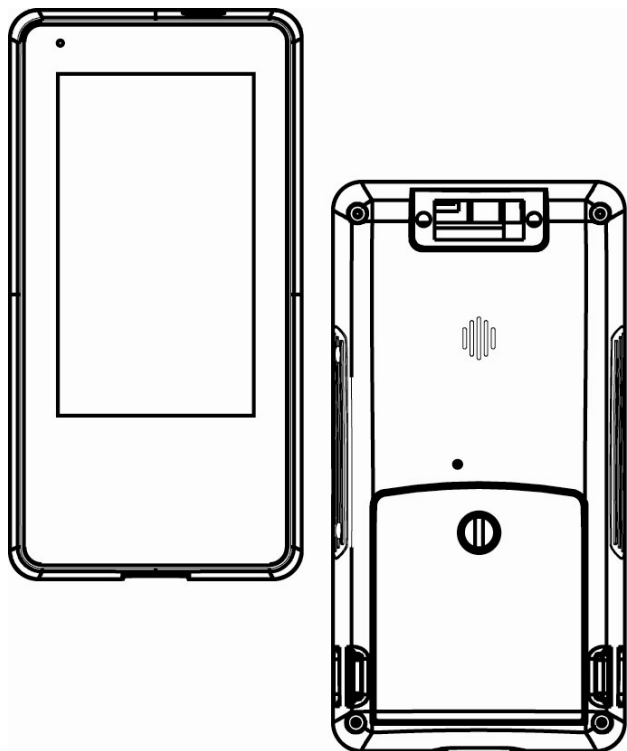

Copyright

Copyright 2010 October
All Rights Reserved
Manual Version 1.1
P/N:

The information contained in this document is subject to change without notice.

We make no warranty of any kind with regard to this material, including, but not limited to, the implied warranties of merchantability and fitness for a particular purpose. We shall not be liable for errors contained herein or for incidental or consequential damages in connection with the furnishing, performance, or use of this material.

This document contains proprietary information that is protected by copyright. All rights are reserved. No part of this document may be photocopied, reproduced or translated to another language without the prior written consent of the manufacturer.

TRADEMARK

The material in this manual is subject to change without notice. Bluetooth is a registered trademark of Bluetooth SIG. Microsoft®, Windows® and ActiveSync® are either registered trademarks or trademarks of Microsoft Corporation. All other product or service names are the property of their respective owners.

Revision History

Changes to the original user manual are listed below:

Version	Date	Description
1.0	2010/03	● Initial release
1.1	2010/10	● MSR module added ● Safety message updated

Safety

Regulatory Information:

Caution: Only use approved and UL Listed accessories, battery packs and battery chargers. Do NOT attempt to charge damp/wet mobile computers or batteries. All components must be dry before connecting to an external power source.

Power Supply

Use only the approved power supply 50-14000-148 output rated 5 Vdc and minimum 2 A. The power supply is certified to EN60950-1 with SELV outputs. Use of alternative power supply will invalidate any approval given to this device and may be dangerous.

Warning for Use of Wireless Devices

Please observe all warning notices with regard to the usage of wireless devices.

Potentially Hazardous Atmospheres

You are reminded of the need to observe restrictions on the use of radio devices in fuel depots, chemical plants etc. and areas where the air contains chemicals or particles (such as grain, dust, or metal powders) and any other area where you would normally be advised to turn off your vehicle engine.

Safety in Aircraft

Switch off your wireless device whenever you are instructed to do so by airport or airline staff.

Pacemakers

Pacemaker manufacturers recommended that a minimum of 15cm (6 inches) be maintained between a handheld wireless device and a pacemaker to avoid potential interference with the pacemaker. These recommendations are consistent with independent research and recommendations by Wireless Technology Research.

Persons with Pacemakers:

Persons with Pacemakers should ALWAYS keep the device more than 15cm (6 inches) from their pacemaker when turned ON and hence they should not carry the device in a breast pocket .

Should use the ear furthest from the pacemaker to minimize the potential for interference.

If you have any reason to suspect that interference is taking place, turn OFF your device.

Hearing Aids

The wireless device may interfere with some hearing aids. In the event of interference you may want to consult your hearing aid supplier to discuss solutions.

Other Medical Devices

Please consult your physician or the manufacturer of the medical device, to determine if the operation of your wireless product may interfere with the medical device.

FCC / EU RF Exposure Guidelines

Safety Information

This device complies with internationally recognized standards covering Specific Absorption Rate (SAR) related to human exposure to electromagnetic fields from radio devices.

Reducing RF Influence - Use Properly

It is advisable to use the device only in the normal operating position.

Handheld Devices

This device was tested for typical body-worn operation. Use only tested and approved belt-holsters, hand strap and similar accessories to ensure FCC Compliance. The use of third-party

belt-clips, holsters, and similar accessories may not comply with FCC RF exposure compliance requirements, and should be avoided.

To comply with FCC RF exposure requirements, this device must be operated in the hand with a minimum separation distance of 2.5 cm or more from a person's body. Other operating configurations should be avoided.

Radio Frequency Interference Requirements - FCC

This device complies with Part 15 of the FCC Rules. Operation is subject to the following two conditions: (1) this device may not cause harmful interference, and (2) this device must accept any interference received, including interference that may cause undesired operation.

CE Marking and European Economic Area (EEA)

The use of 2.4GHz RLAN's, for use through the EEA, have the following restrictions:

- Maximum radiated transmit power of 100 mW EIRP in the frequency range 2.400 -2.4835 GHz
- France, outside usage is restricted to 2.4 - 2.454 GHz.
- Italy requires a user license for outside usage.

Bluetooth® Wireless Technology for use through the EEA has the following restrictions:

- Maximum radiated transmit power of 100mW EIRP in the frequency range 2.400 -2.4835 GHz
- France, outside usage is restricted to 10mW EIRP
- Italy requires a user license for outside usage.

Battery Information

Our rechargeable battery packs are designed and constructed to the highest standards within the industry.

However, there are limitations to how long a battery can operate or be stored before needing replacement.

Many factors affect the actual life cycle of a battery pack, such as heat, cold, harsh environmental conditions and severe drops.

When batteries are stored over six (6) months, some irreversible deterioration in overall battery quality may occur. Store batteries discharged in a dry, cool place, removed from the equipment to prevent loss of capacity, rusting of metallic parts and electrolyte leakage. When storing batteries for one year or longer, they should be charged and discharged at least once a year. If an electrolyte leakage is observed, avoid any contact with affected area and properly dispose of the battery. Batteries must be charged within the 32° to 95° F (0° to +35° C) ambient temperature range.

Replace the battery when a significant loss of run time is detected.



Battery Caution

Risk of explosion if battery is replaced by an incorrectly type. Dispose of used battery according to the local disposal instructions.



Safety Caution

Note: To comply with IEC60950-1 Clause 2.5 (limited power sources, L.P.S) related legislation, peripherals shall be 4.7.3.2 "Materials for fire enclosure" compliant.

4.7.3.2 Materials for fire enclosures

For MOVABLE EQUIPMENT having a total mass not exceeding 18kg.the material of a FIRE ENCLOSURE, in the thinnest significant wall thickness used, shall be of V-1 CLASS MATERIAL or shall pass the test of Clause A.2.

For MOVABLE EQUIPMENT having a total mass exceeding 18kg and for all STATIONARY EQUIPMENT, the material of a FIRE ENCLOSURE, in the thinnest significant wall thickness used, shall be of 5VB CLASS MATERIAL or shall pass the test of Clause A.1



Waste Electrical and Electronic Equipment (WEEE)

English: For EU Customers: All products at the end of their life must be returned to the reseller for recycling.

Notational Conventions

The following conventions are used in this document:

- ◆ Italics are used to highlight specific items in the general text, and to identify chapters and sections in this and related documents.
- ◆ bullets (•) indicate:
 - action items
 - lists of alternatives
 - lists of required steps that are not necessarily sequential
 - Sequential lists (e.g., those that describe step-by-step procedures) appear as numbered lists.

NOTE This symbol indicates something of special interest or importance to the reader. Failure to read the note will not result in physical harm to the reader, equipment or data.

CAUTION This symbol indicates that if this information is ignored, the possibility of data or material damage may occur.

WARNING! This symbol indicates that if this information is ignored the possibility that serious personal injury may occur.

Table of Contents

1	Introduction	12
1-1	System Overview	12
1-2	Standard Components.....	13
1-3	Optional Accessory	14
1-4	Hardware Description.....	15
1-5	System Feature Description	18
2	Getting Started	21
2-1	Installing / Uninstalling a Micro SD Card	21
2-2	Install a Wrist Strap	22
2-3	Install a Hand Strap	22
2-4	Charging the System.....	23
2-5	Backup Battery	24
2-6	Power on/off the Unit.....	25
2-7	Install a 4-Slot System Charging Cradle (Optional)	26
3	Using the System	27
3-1	Wi-Fi Connection Settings.....	27
3-1-1	Connecting to an Existing Network.....	27
3-1-2	Adding a New Network	29
3-1-3	Enhancing the WiFi Connection	30
3-1-4	SSID Lock Function	31
3-2	Synchronization via USB Cable	32
3-2-1	Mini USB Cable	32
3-2-2	Installing WindowsCE® ActiveSync® application	33
3-2-3	Installing the USB Cable.....	34
3-2-4	Start the Synchronization.....	35
3-3	Backup and Restoring the System	37
3-3-1	Backup the System.....	37
3-3-2	Restoring the System	38
3-4	Switching the Admin / User mode	39
3-5	Power Management Settings	40

3-5-1	CPU Power Mode Settings	40
3-5-2	System Configuring Power Mode Settings	41
3-5-3	Display Backlight Settings	42
3-5-4	WiFi Power Mode Settings	43
3-6	Display Rotation	44
3-7	LED Indicator Description.....	45
3-8	Resetting the Mobile System.....	46
3-8-1	Reset to the Factory Default Settings	46
3-8-2	Cold Boot.....	47
3-9	OS Image Update steps	48
3-9-1	Unzip the RAR compressed file to Micro SD root directory.....	48
3-9-2	Image update procedures.....	49

4 Application Programming Interface .. 51

4-1	Windows Embedded CE 5.0 Standard	51
4-2	Non WindowsCE Standard.....	55
4-2-1	Admin/User Mode Application.....	55
4-2-2	Overwrite Factory Default	57
4-2-3	Vibration notification feature	65

1

Introduction

This chapter introduces the parts, accessories of the mobile system.

1-1 System Overview

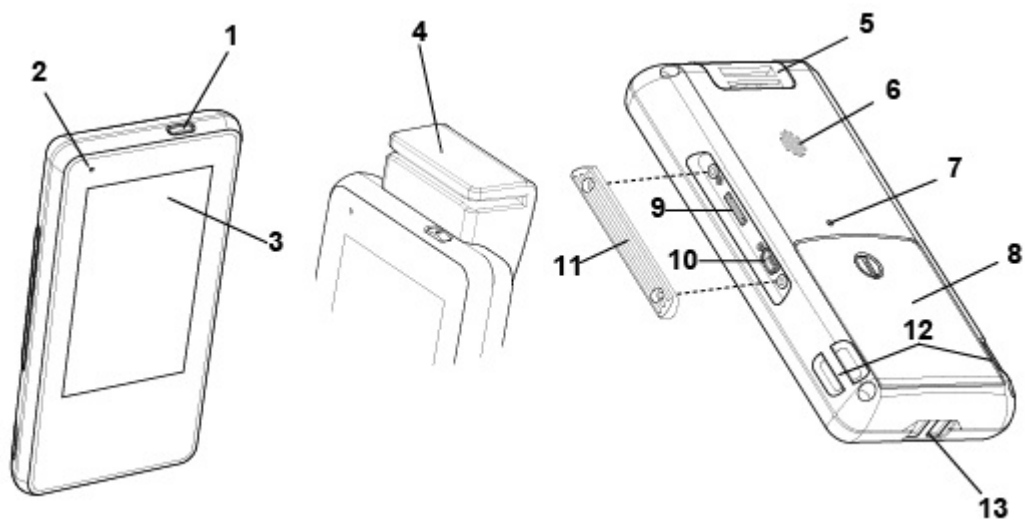

System Overview table -1

Location	
1	Power Button
2	LED Indicator
3	4.3" TFT with Touch Screen
4	MSR module
5	Hand Strap Installation Ring
6	Speaker
7	Reset Hole
8	Battery Door
9	Micro SD slot
10	Mini USB connector
11	I/O Cover
12	Hand Strap / Wrist Strap Installation Ring at both sides
13	Charging Slot

1-2 Standard Components

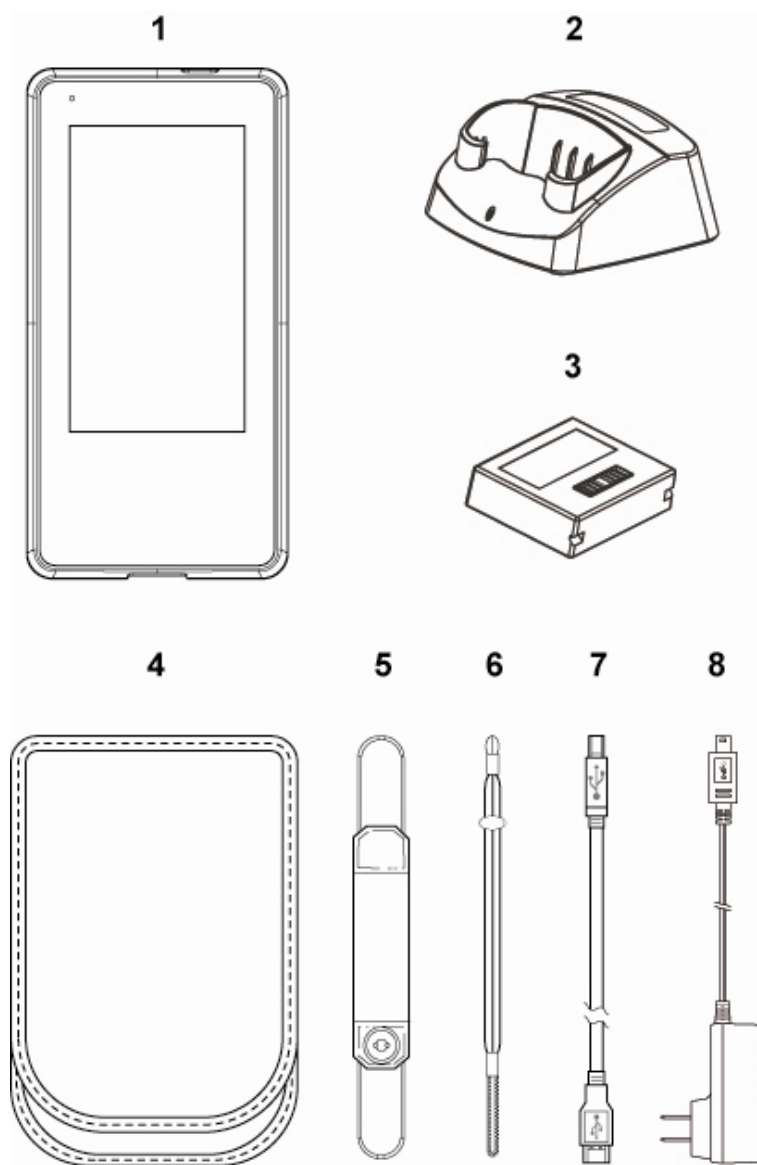

Items	
1	Mobile system
2	Single slot system charger Cradle
3	Main battery
4	Holster
5	Hand strap
6	Wrist strap
7	USB cable (connecting with PC for synchronization)
8	USB-AC Adapter for connecting to single slot system charging cradle

1-3 Optional Accessory

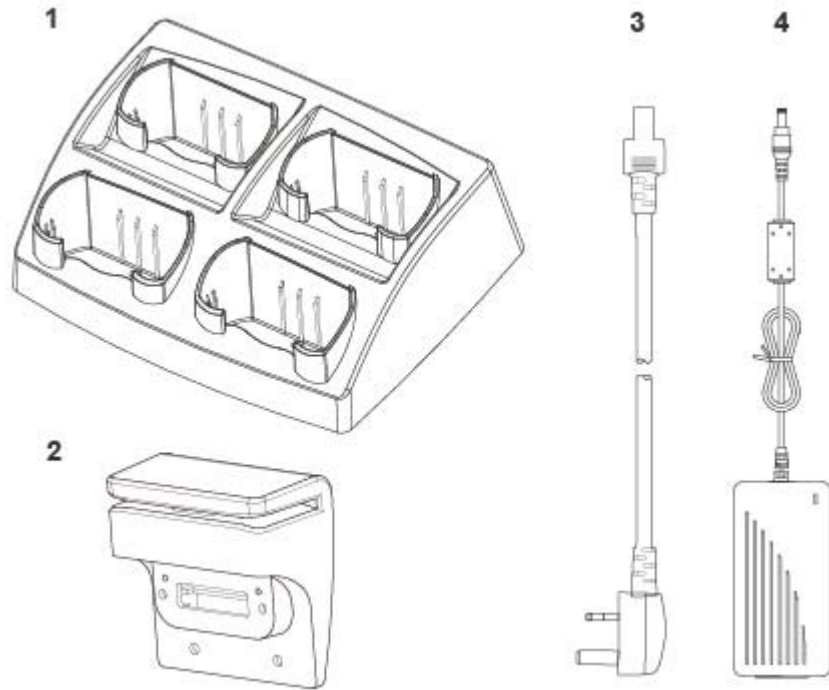

Items	
1	4-slot system charger cradle
2	MSR module (will be installed prior to shipping)
3	Power cord for 4-slot system charging cradle
4	Power adapter for 4-slot system charging cradle

1-4 Hardware Description

Item	Features	Descriptions
1	Main Processor	<ul style="list-style-type: none">● Marvell PXA270 416MHz (Xscale Core)
2	System Memory	<ul style="list-style-type: none">● 128Mbytes SDRAM● Approximately 115MB used for system operation remainder for storing system loader and data
3	System Storage	<ul style="list-style-type: none">● 1Gbytes Flash (ROM file system)● More than 300MB for storing WindowCE image and OEM application programs● Approximately 600MB left for system and user storage.● Approximately 100MB left for storing OEM data and configuration
4	Display	<ul style="list-style-type: none">● PXA270 Display controller● Shared System Memory Video Frame Buffer● Resolution :480 x 272 pixels, 16 bit color● 4 way Orientation Detector
5	LCD	<ul style="list-style-type: none">● 4.3 inches TFT LCD – WQVGA (480 x 272 pixels resolution)● Transmissive display mode● Digital RGB 8bit color depth, 8 LED backlight

Item	Features	Descriptions
6	Touch Panel	<ul style="list-style-type: none"> ● LCD panel with touch ● Resistor 80% Transparency (Film to Glass type)
7	Audio	<ul style="list-style-type: none"> ● Stereo audio system with mono speaker design ● 1W speaker amplifier
8	Secure Digital Socket	<ul style="list-style-type: none"> ● Micro SD memory card (Support up to: 2Gbytes)
9	WiFi IEEE 80211b/g	<ul style="list-style-type: none"> ● Auto fallback mode : 6M~54M(80211g), 1M~11M(80211b) ● Complies with Wireless Ethernet Compatibility Alliance ● Supports hardware signaling BT WiFi coexistence ● Link LED indicator ● Maximum Output Power : +12dBm
10	USB Client	<ul style="list-style-type: none"> ● USB Specification – 1.1 compliant ● Full-Speed operation on half-duplex at 12Mbps baud rate
11	USB Host	<ul style="list-style-type: none"> ● Compliant with USB Specification 1.1 and OHCI Spec ● Supports both low-speed and full-speed USB devices ● Supports optional MSR

Item	Features	Descriptions
12	Power / Reset buttons	<ul style="list-style-type: none"> ● Power Button : Suspend/ Resume Device and Power-on Key ● Reset Button : Warm Reset ● Press Power and Reset buttons simultaneously: Cold Reset
13	LED indicators	<ul style="list-style-type: none"> ● Green: Battery charging finished ● Orange: Battery charging ● Blue: WiFi link active ● Red: Flashing – Battery low On – Critical low battery
14	Vibrator	<ul style="list-style-type: none"> ● Vibration indicator
15	Battery	<ul style="list-style-type: none"> ● Liton battery pack 3.7V 2200 mA/h ● Charging time : maximum 4.0 ~ 4.5Hours ● Thermal / Over Charging Protections
16	Adapter	<ul style="list-style-type: none"> ● AC110V ~ 240V / DC5V (10W) 50~60Hz

1-5 System Feature Description

Item	Features	Descriptions
1	Application	<ul style="list-style-type: none"> ● File Explorer ● Internet Explorer 6.0 for Windows CE ● Windows Media Player ● Windows CE standard shell (Windows XP-like skin)
2	File System	<ul style="list-style-type: none"> ● ROM File system with hive registry
3	Graphic / Display	<ul style="list-style-type: none"> ● 480x272x16 (Landscape mode) as panel default mode 272x480x16 (Portrait mode) as system default mode ● Compliant with Graphics, Windowing and Event Subsystems of Window CE embedded. ● Still Image Codec Support ● DirectShow ● Supports screen rotation feature
4	User Input Interface	<ul style="list-style-type: none"> ● Stylus input rather than mouse input capability
5	Audio	<ul style="list-style-type: none"> ● Audio playback feature only ● Support waveform audio Input/Output device APIs ● Configurable sound enable/disable feature of system event, message notification, screen taps. ● MP3 Codec ● MPEG-1 Layer 1 and 2 audio codec ● Waveform audio renderer ● WMA Codec

Item	Features	Descriptions
6	Storage	<ul style="list-style-type: none"> Removable storage : Micro SD memory (up to 2GB) Storage: NAND flash memory (On Board)
7	Data Communication WLAN	<ul style="list-style-type: none"> Support seamless roaming in IEEE802.11b/g WLAN authentication infrastructure Support single SSID Support fast Wi-Fi roaming WPA and 802.11i security standard (AES/CCMP and WEP with TKIP security mechanism) Support Windows Wireless Zero Configuration service
8	Data Communication Bluetooth	<ul style="list-style-type: none"> Compliant Bluetooth software specification Windows CE Bluetooth communication software stack "SPP" "FTP" "Activesync" profile supports Support Winsock Bluetooth programming interface
9	Data Synchronization	<ul style="list-style-type: none"> Bluetooth Windows CE Active-sync USB SD card reader
10	Vibration Notification	<ul style="list-style-type: none"> Support Programming API of Windows CE device manager
11	System Power State	<ul style="list-style-type: none"> Supports Remote Application Interface (RAPI) for retrieving the power status of the system
12	Backlight	<ul style="list-style-type: none"> Supports Programming API of Windows CE device manager Supports 10 backlight levels

Item	Features	Descriptions
13	Network Features	<ul style="list-style-type: none"> ● NDIS network driver architecture ● TCP/IP ● Windows Networking API /Redirector [SMB] ● WinSock Support
14	Security	<ul style="list-style-type: none"> ● Authentication Services (SSPI) ● Credential Manager ● CryptoAPI 1.0
15	Applications and Service Development	<ul style="list-style-type: none"> ● .NET compact framework 2.0 ● Active Template Library (ATL) ● C Libraries and Runtimes ● COM and DCOM ● Microsoft Foundation Classes (MFC) ● Object Exchange Protocol ● Standard SDK for Windows CE ● MSXML 3.0
16	Fonts	<ul style="list-style-type: none"> ● Courier New (Subset 1_30) ● Tahoma (Subset 1_07) ● Wingding
17	Multilingual	<ul style="list-style-type: none"> ● English (English software Input Panel) ● Traditional Chinese (Bopomofo/ Chan Jei software Input Panel, Handwriting) ● Simplified Chinese (Shuang Pin software Input Panel)
18	OEM	<ul style="list-style-type: none"> ● OEM Device Manager ● User mode / Admin mode operation modes

2

Getting Started

2-1 Installing / Uninstalling a Micro SD Card

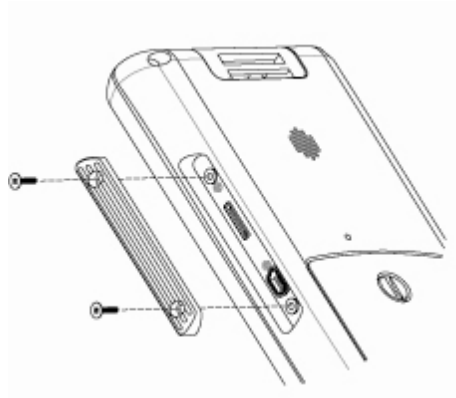

1. Release the screws (x2) to open the I/O cover on the side of the mobile system.
2. The Micro SD slot is a push-push type. Please push the Micro SD card into the slot to install a micro SD card or push again and take it out to remove it.

2-2 Install a Wrist Strap

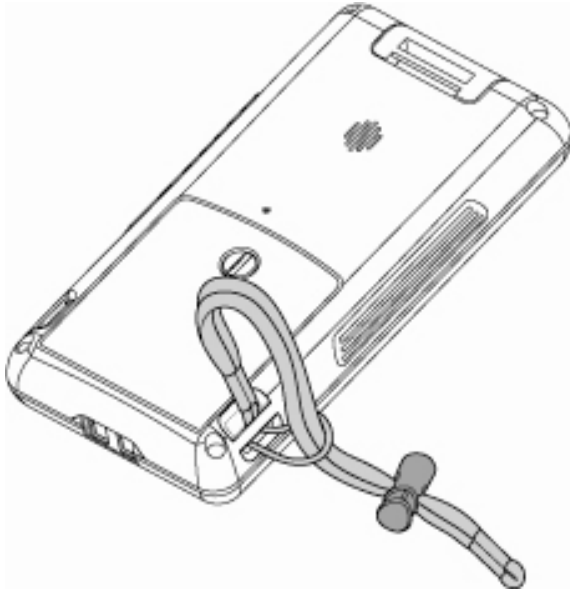

1. Thread the wrist strap provided through the strap ring as pictured.

2-3 Install a Hand Strap

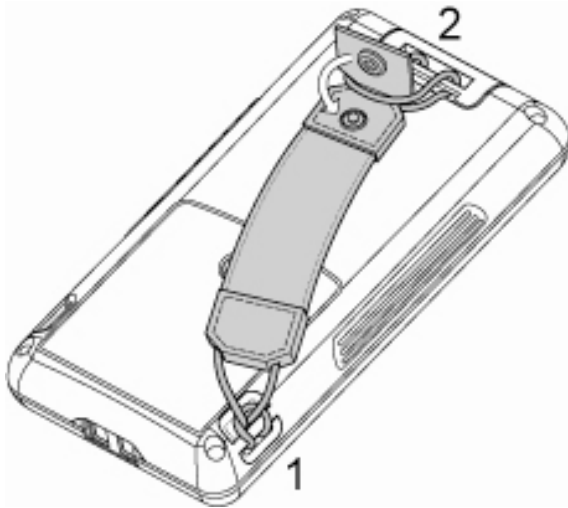

2. Thread the hand strap through the strap ring on either side of the system.
3. Thread the hand strap through the plastic ring on the back of the device and lock it to the hand strap

2-4 Charging the System

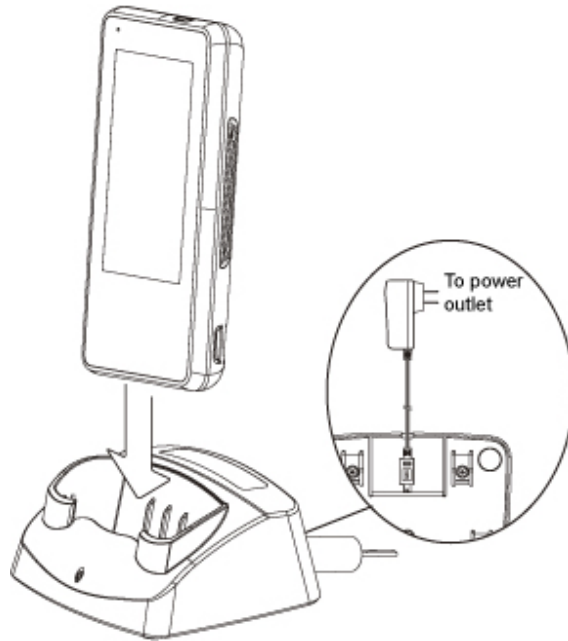

1. Connect the mini USB/AC Adapter to the bottom of the charging cradle.
2. Connect the power cord of the AC-USB adapter to the power outlet.
3. Slide the Mobile computer into the charging cradle. You should see the charging LED appear.

2-5 Backup Battery

The internal Backup Battery has a 5 minute duration. The unit will instantly resume functionality when battery is replaced within 5 minutes.



If battery is replaced outside of the 5 minute battery backup the system will reset and power on automatically.

- **Note:** Normal procedure to power on the system is to hold down the Power Button for 4 seconds

2-6 Power on/off the Unit



Power on the Unit

Press and hold the Power Button for 3 seconds to turn on the unit.

Power down the Unit

Press the Power Button for 4 seconds or select the "Start Menu"> "Suspend" to power down the unit.

2-7 Install a 4-Slot System Charging Cradle (Optional)

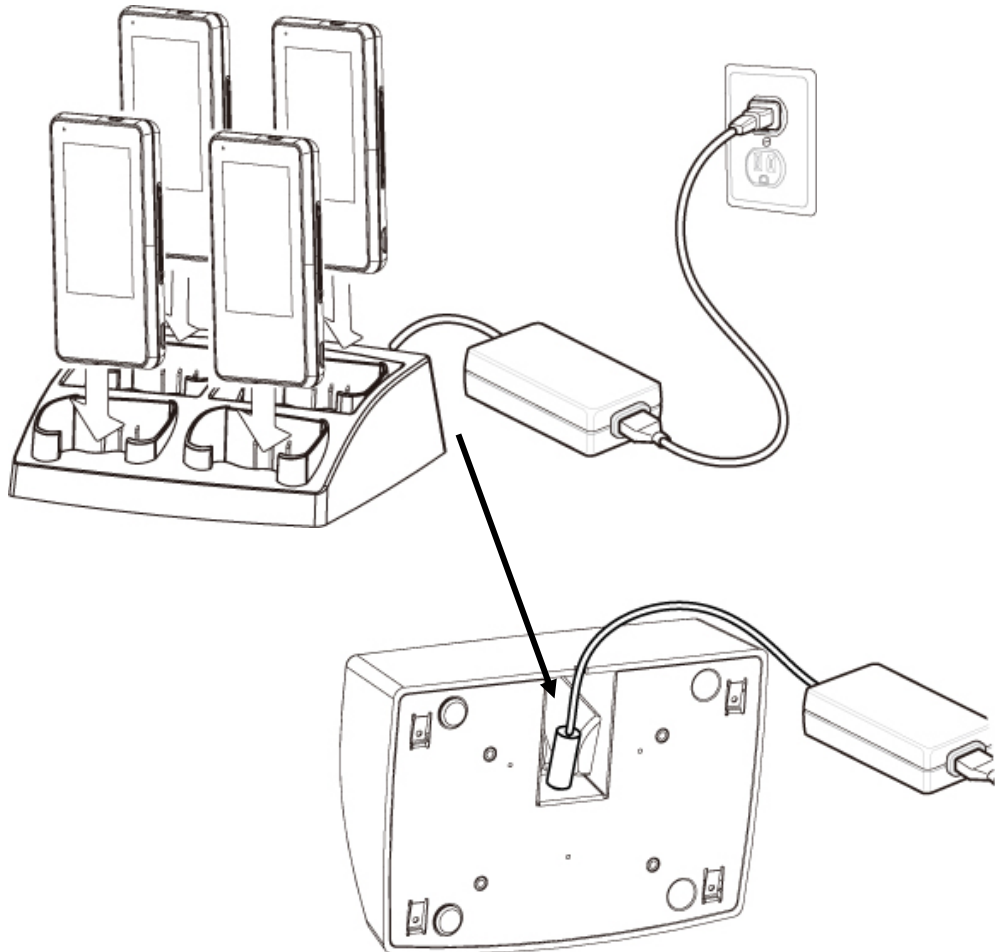

1. Connect the power adapter and the power cord to the 4-slot system charging cradle.

3

Using the System

3-1 Wi-Fi Connection Settings

3-1-1 Connecting to an Existing Network

Enable Wireless Connection

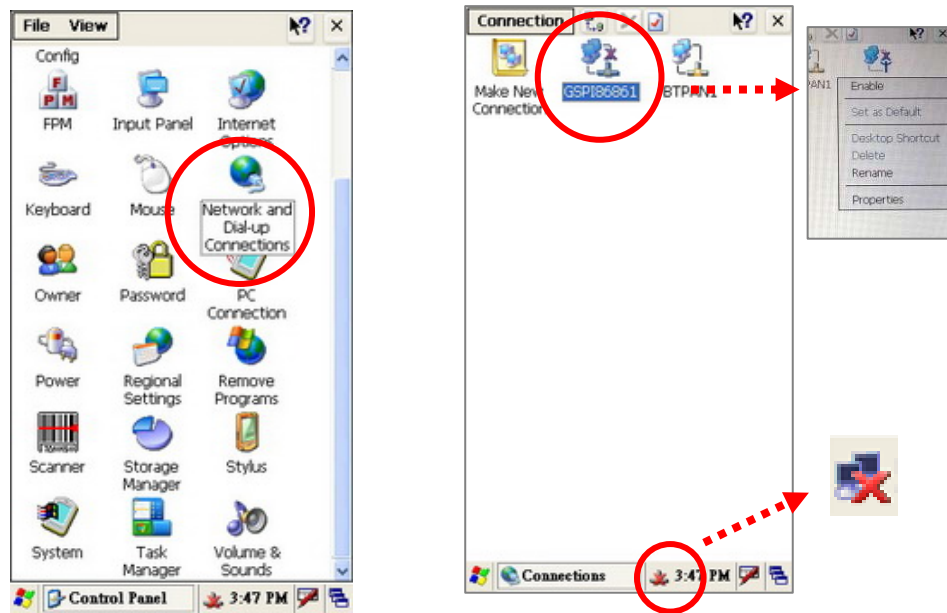

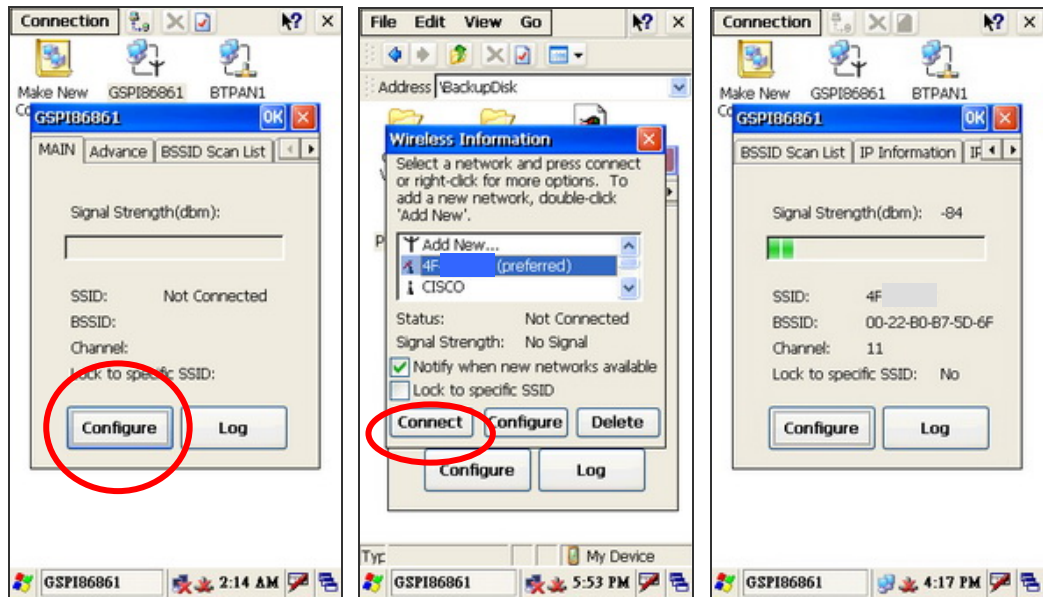

1. Enable the Wireless Connection by selecting "Start" > "Settings" > "Control Panel" > "Network and Dial-Up Connections".
2. Right click on the "GPS186861" and tap the "Enable" icon in the drop down menu to access the wireless connection.
3. After Enabling the "GPS186861", you will see the Icon  appear in the system tray.

Select a Network and get connection



4. You will see the “GSPi86861” window pop up after you double click on the icon .
5. Press “Main” tab and “Configure” button.
6. Select the network you want and put the key (password) if needed, then press “Connect” button to get connection.

➤ **NOTE:** You can create a new network by selecting “Add New...” (please see Chapter 3-1-2)

7. After the WiFi is successfully connected a message will show the status of the connection and the icon () in the system tray will turn to ().

3-1-2 Adding a New Network

To add a new network connection, please enable the wireless connection first by following the steps in Chapter 3-1-1.

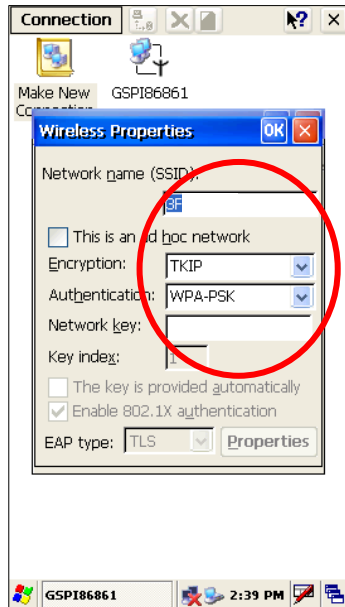

1. The "Wireless Properties" dialog box pop up after pressing "Add New...".
2. Enter the Network name of the Network you would like to connect to in the "Network name(SSID)" box. The select the Encryption and Authentication methods, enter the password in the "Network key" .
3. You will have a successful connection when the Status shows "Connected to xxx"

3-1-3 Enhancing the WiFi Connection

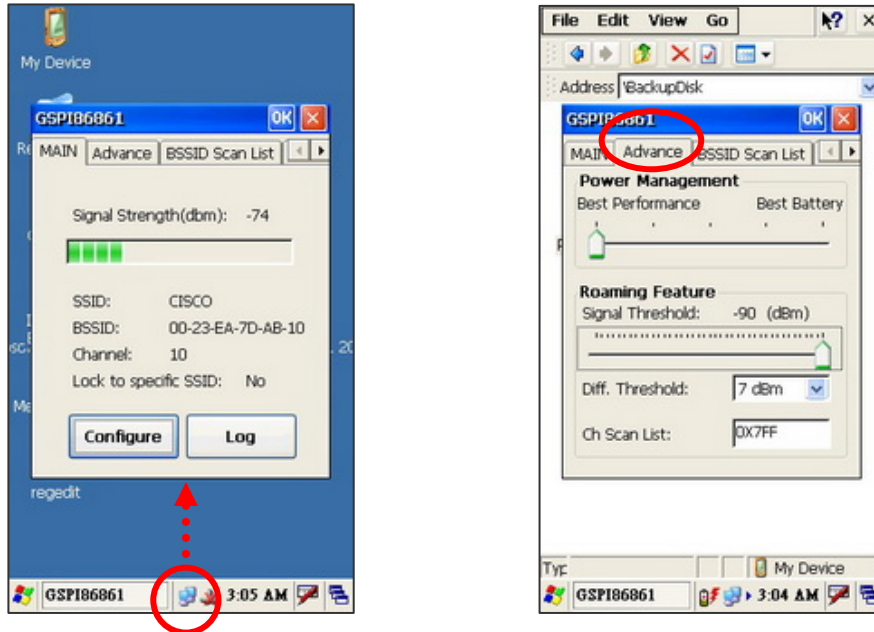

If the Signal Strength of the WiFi Connection remains low follow these steps:

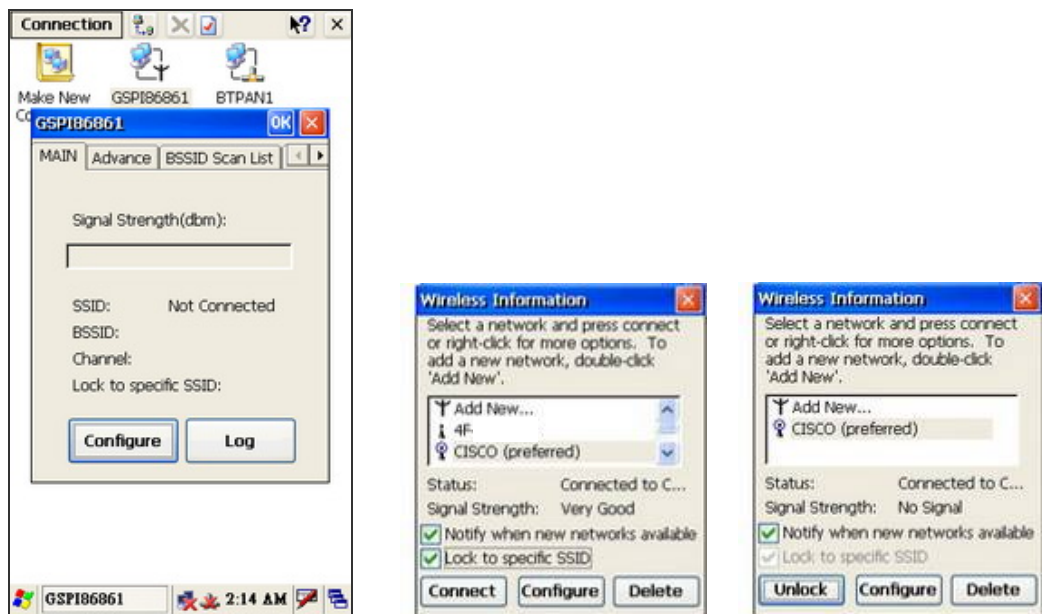

1. Please double-click on the icon  in the system tray. The “GSP186861” dialog will appear.
2. Please select “Advance” tab and move the “Power Management” to the “Best Performance level” and the “Roaming Feature” to the far right.
3. Press “OK” to save the settings.

3-1-4 SSID Lock Function



1. Enable Wireless Connection by following the steps in Chapter 3-1-1.
2. After enabling the Wireless Connection, the icon () will appear in the system tray. Double click the icon() and press the "configure" button on the "GPSI86861" window.
3. Select a network you want and click the "Lock to specific SSID" check box. Click "Connect" button to lock the SSID.
4. SSID is locked successfully when the "Status" shows "Connected to xxx" on the Wireless information window.

3-2 Synchronization via USB Cable

3-2-1 Mini USB Cable

When Developing and debugging software use the WindowsCE® ActiveSync® function via the USB Port.

USB Cable Snapshot



Optional USB Cable is for Synchronization with the PC and Software uploading and Debugging.

3-2-2 Installing WindowsCE® ActiveSync® application

To synchronize the Mobile System with PC, please install the “Microsoft Active Sync” program on each PC first.

The set-up of a “Partnership” will be requested once after connecting the USB Cable to the Mobile System and PC.



The Synchronization will run automatically after "Microsoft Active Sync" and "Partnership Set-up" install successfully and the USB cable is connected.

Refer to the Microsoft Official Website for details installation procedures for the ActiveSync program.

3-2-3 Installing the USB Cable

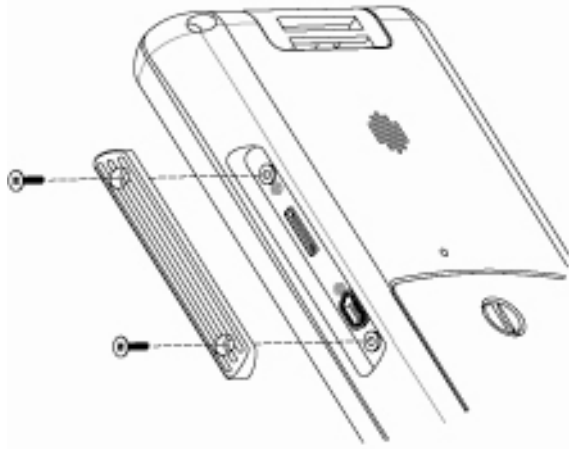

1. Unscrew the screws (x2) to open the I/O cover and access the mini USB connector.

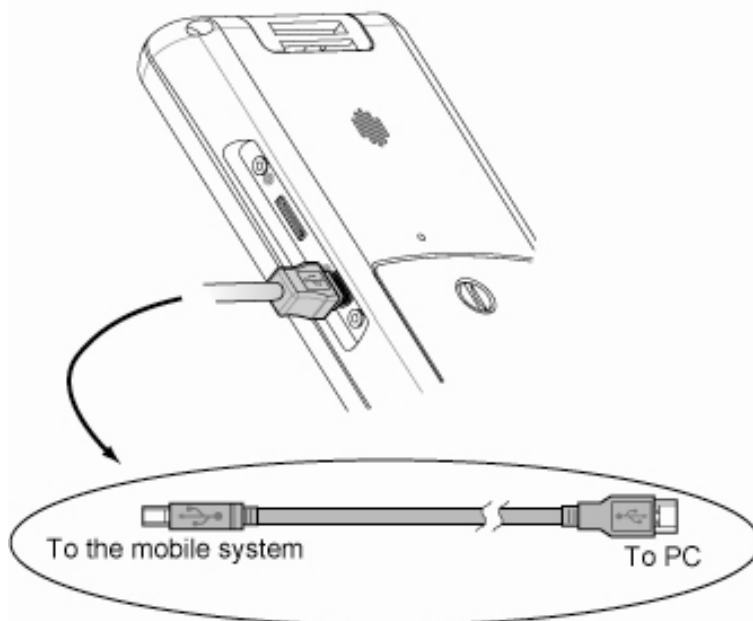

2. Connect the mobile system and the PC with the mini USB cable.

3-2-4 Start the Synchronization

The connection will automatically run and you can see the “USB Status” dialog pop up after you connect the mobile system and a PC with the mini USB cable provided.

- Note: please install the “Microsoft® ActiveSync®” program at your PC before you start the synchronization.



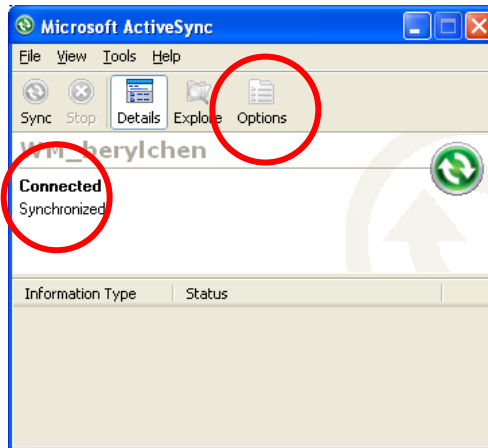

1. The "Microsoft ActiveSync" window will show "Connected" after USB Cable is successfully connected.

➤ **Note:** Use the "Options" to set up the Synchronization on your own.

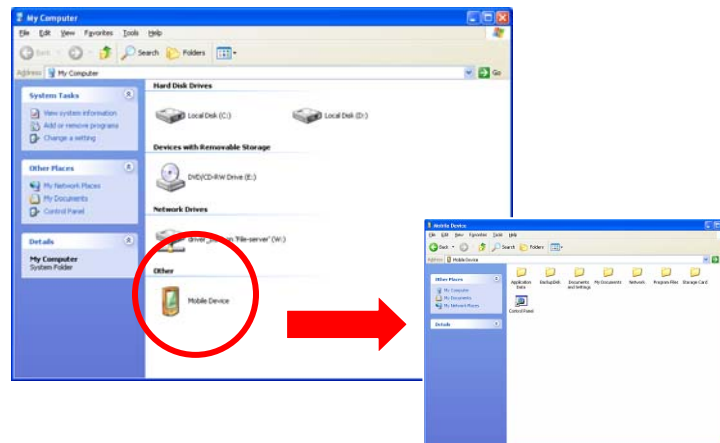

2. Double click the "Mobile Device" icon by opening "My Computer" to access the documents or files saved in the Mobile System.

3-3 Backup and Restoring the System

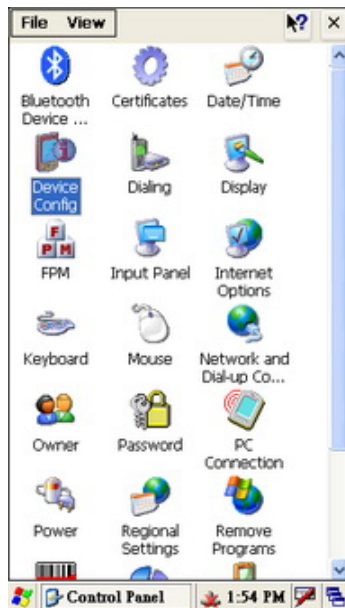

Go to “Start” > “Control Panel” > “Device Config”.

3-3-1 Backup the System

To restore the system, please follow the instructions in Chapter 3-4 and the following steps.

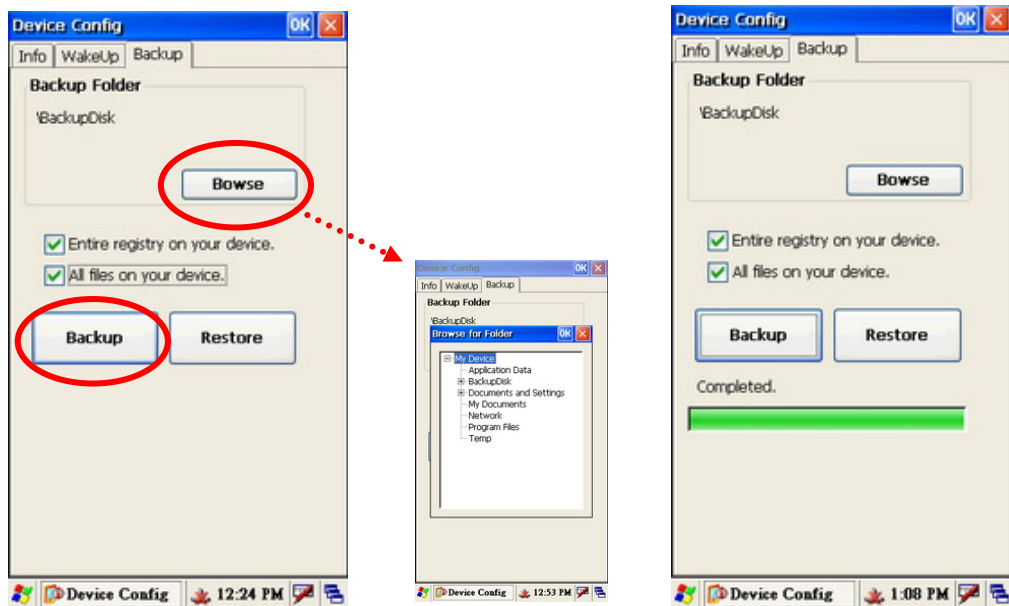

1. Select “Backup” tab then enable the “Entire the registry on your device” and the “All your files on your device” check boxes.

2. Press the "Browse" to select the location to save the Backup Files.
3. Press the "Backup" button to start the backup process.

3-3-2 Restoring the System

To restore the system, please follow the Chapter 3-4 and following instructions.

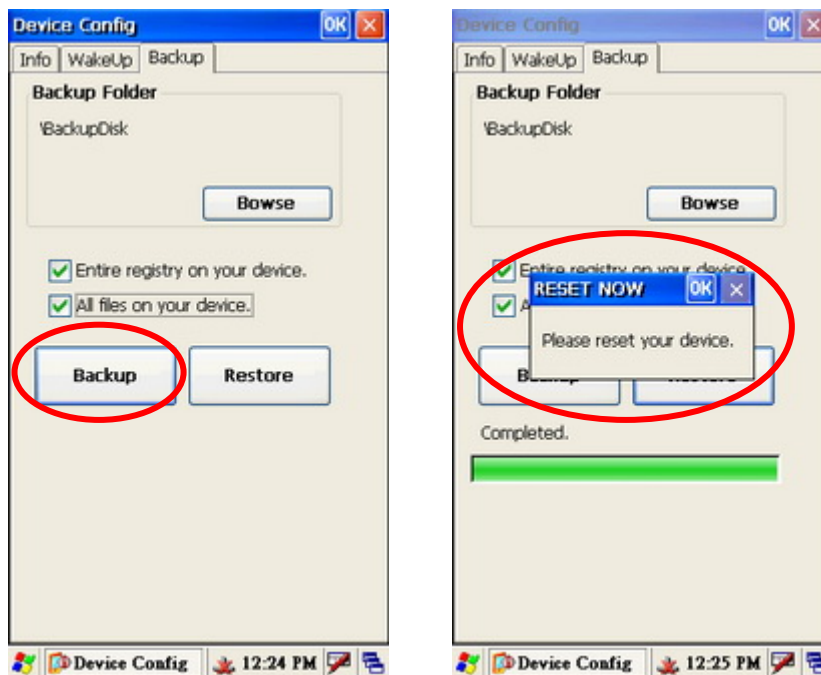

1. Press "Restore".
2. Press "OK" to finish the Restore.

➤ **Note:** System Restore means to restore the system to the latest "Backup" version.

3-4 Switching the Admin / User mode

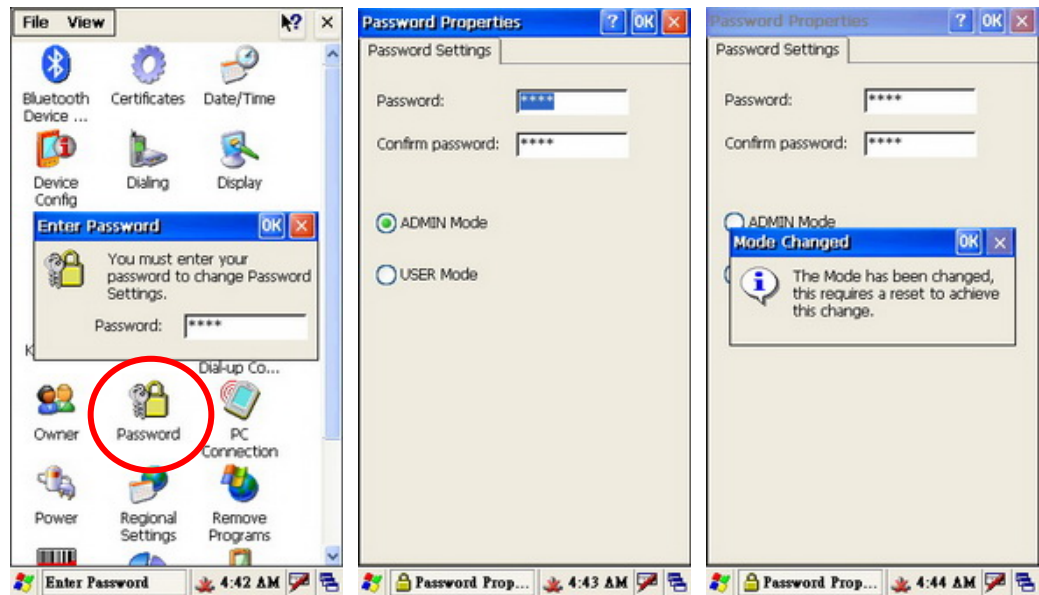

1. To access the Mode Change screen "Start Menu" > "Settings" > "Control Panel" > "Password" > Enter Password (default is 1111).
2. The "Password Properties" dialog will popup after entering the password (default), select the Mode you want. Press "OK" to save the setting.
3. Once saved the "Mode Changed" dialog will popup. Press "OK" to restart the system.

3-5 Power Management Settings

3-5-1 CPU Power Mode Settings

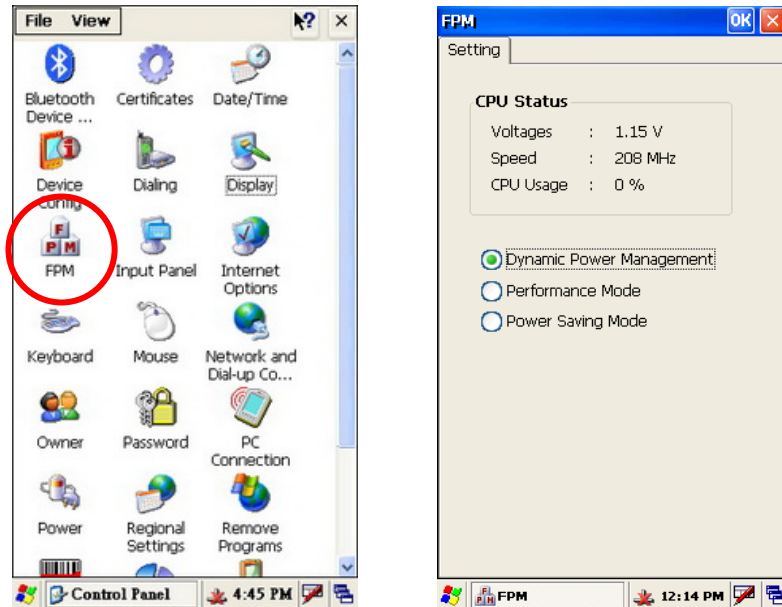

1. Select "Start" > "Control Panel" > "FPM" button
2. Select the mode you want on the "FPM" window.

➤ **Note:** The CPU Power Consumption is ranked as:
"Performance Mode" > "Dynamic Power Management" > "Power Saving Mode".

3-5-2 System Configuring Power Mode Settings

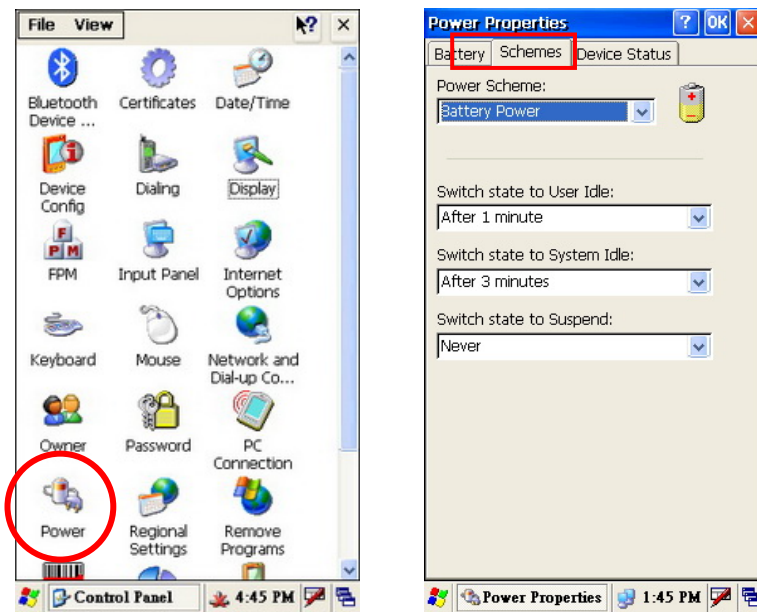

1. Click "Start" > "Control Panel" > "Power" button
2. Select "Schemes" tab.
3. Set up the power mode as "Battery Power" or "AC Power" in the "Power Scheme" drop down menu.
4. Set the times for turning the Mobile System off or going in to standby mode.
 - a. Switch state to User Idle.
 - b. Switch state to System Idle.
 - c. Switch state to suspend.
5. Press "OK" to save the settings.

3-5-3 Display Backlight Settings

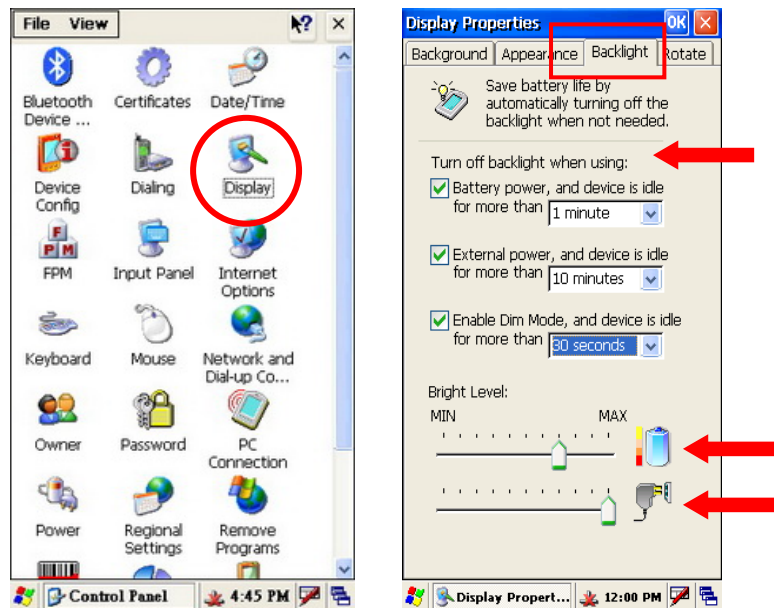

1. Go to "Start" > "Control Panel".
2. Double click on the "Display" icon.
3. In the "Display Properties" window, select "Backlight" tab.
4. You can enable the backlight savings by checking and setting turn-off time in the checkboxes of "Battery power...", "External power..." and "Enable Dim Mode..."
5. Drag the "Bright Level" slider to set the level for both Battery power and External power.
6. Press "OK" to save the settings.

➤ **Note:** If you enable the "Dim Mode" it runs in dim mode until using the plans set above.

3-5-4 WiFi Power Mode Settings

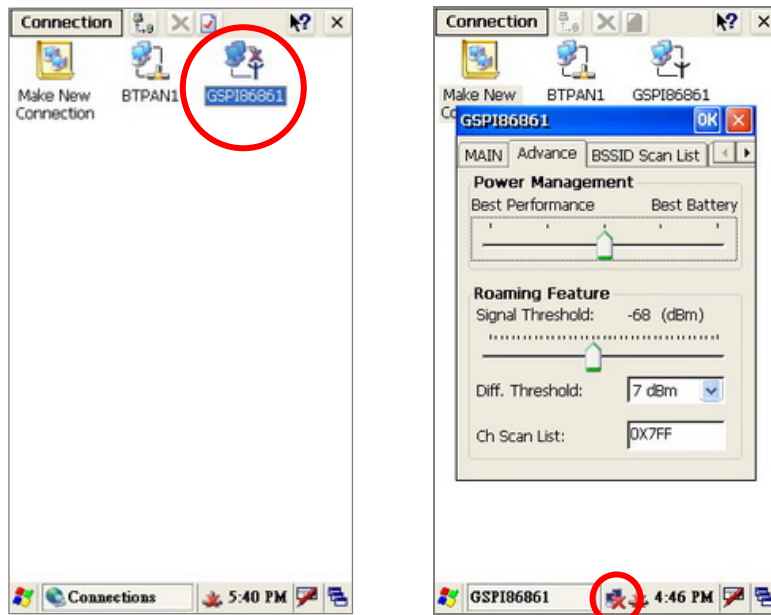

1. To access the network connections select "Start" > "Control Panel" > "Network and Dial-up Connections".
2. Hold and press "GSPi86861" button until the drop down menu appears.
3. Press "Enable" in the drop down menu to activate the WiFi Connection or press icon  in the system tray directly to activate the "GSPi86861" setup window as above right figure.
4. Tap the "Advanced" tab of the "GSPi86861".
5. Set the "Power Management" by dragging the slider on the "Best Performance - Best Battery" scale.

➤ **Note:** To conserve more battery power, drag the slider toward the "Best Battery" which also reduces the WiFi signal performance.
To improve signal performance, drag the slider toward the "Best Performance" which also consumes more power and shortens the battery life.

3-6 Display Rotation

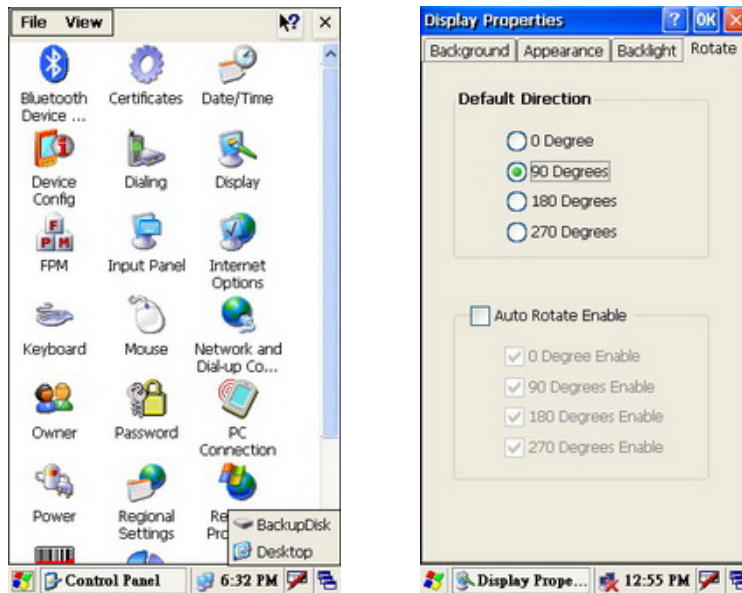

1. Open Start > Control Panel
2. Press “Display” icon.
3. Select “Rotate” tab in the “Display Properties” dialog.

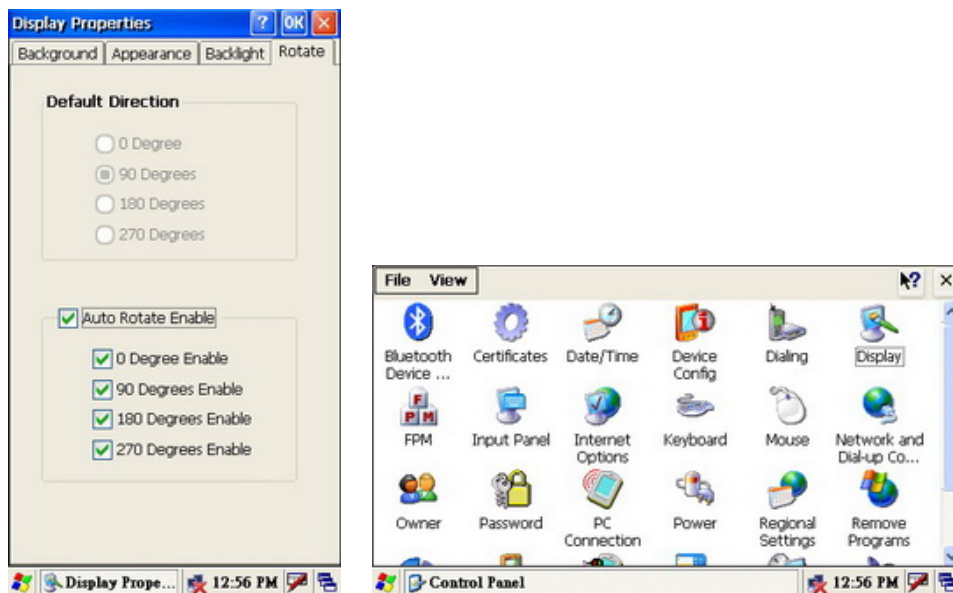

4. Check the options you want to set up for the display rotation mode.
5. Display will rotate according to your previous setup.

3-7 LED Indicator Description

The LED indicator is located in the front of the Mobile System which indicates the status. Power on/off , Main Battery and WiFi Link. The description is as follows:



Green color LED: Battery power charging state

LED ON: Battery power charging finished (100%)

Orange color LED: Battery power charging state

LED ON: Battery power charging

Blue color LED: Link status of WiFi manager

LED ON: WiFi link active

Red color LED: Battery power state

LED Flash: Battery low

LED ON: Critical battery low

3-8 Resetting the Mobile System

The mobile system has the ability "Reset to factory default settings" and "cold boot". The detail procedures as bellows:

3-8-1 Reset to the Factory Default Settings

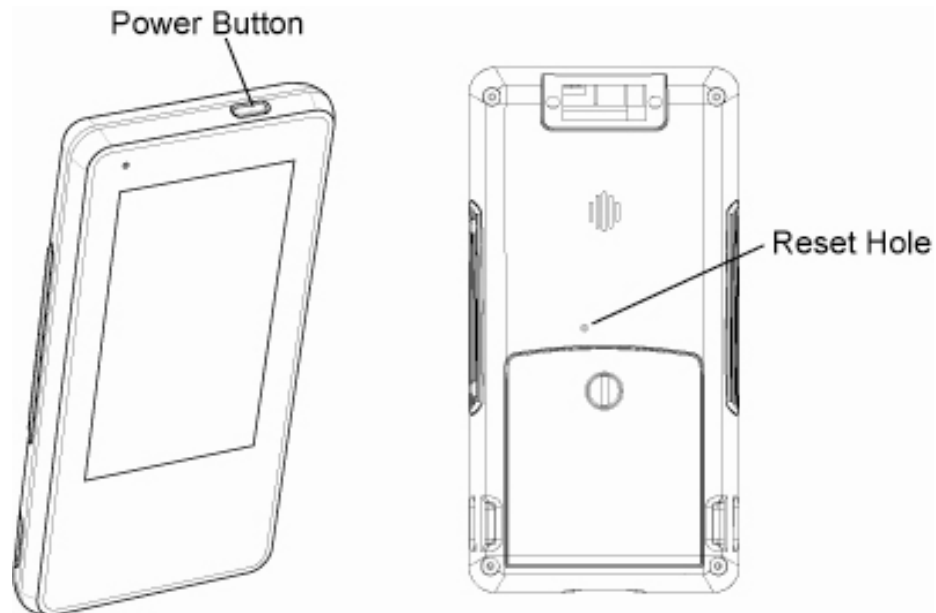

1. Use a tool to gently press the "Reset Hole" on the rear of the mobile system while holding down the "Power Button" until the system vibrates.
2. Keep depressing the power button and press the "Reset Hole" once, the system them will start the calibration instructions. Finish the calibration process to complete the "Reset to factory defaults".

3-8-2 Cold Boot

Refer to Chapter 3-8-1 for power button and reset hole instructions.

3. Use a tool to gently press the "Reset Hole" on the rear of the Mobile System while depressing the "Power Button".
4. Release the "Reset Hole" and "Power Button" at the same time after the system vibrates.



5. The system will reboot to the desktop.

➤ **Note:** The desktop slightly varies according to the OS version installed.

3-9 OS Image Update steps

3-9-1 Unzip the RAR compressed file to Micro SD root directory

You will find two directories from the root directory of Micro SD card which the directories to be unzipped from RAR file.

File descriptions:

Directory 1: "CE5.0-Vxx.xx" -- WindowsCE 5.0 OS image revision

Including : Eboot.bin -- OS Image loader

nk.bin -- OS Image

Target_m.txt -- Image of system power manager

Directory 2: "UpdateImage" -- Image update tool

Including : OS_DOWNLOAD.exe -- Execution file of Image update tool

OS_DOWNLOAD.cfg -- Configuration file of Image update tool

MCU_UPDATE.exe -- Companion file of Image update tool

FormatPartitionCE5.dll -- WinCE5.0 driver of Image update tool

FormatPartitionCE6.dll -- WinCE6.0 driver of Image update tool

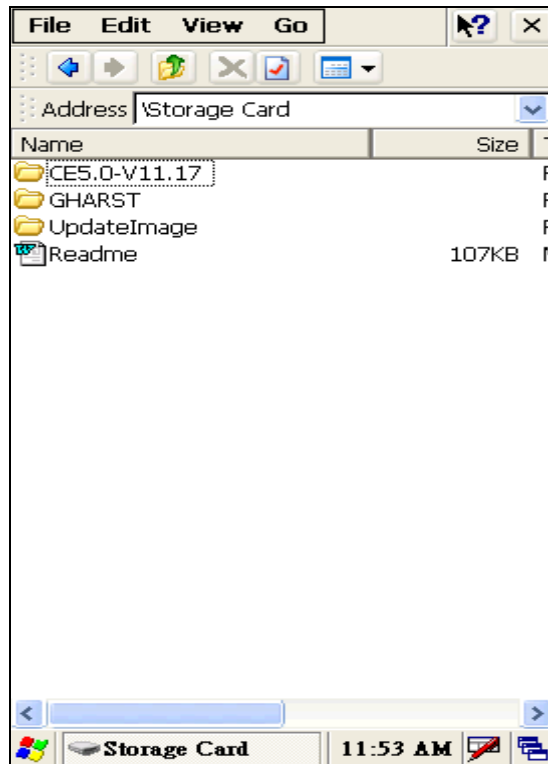

3-9-2 Image update procedures

■ Execute image update tool

1. Go to “UpdateImage” directory.
2. Double click “OS_DOWNLOAD.exe” icon to run image update tool.

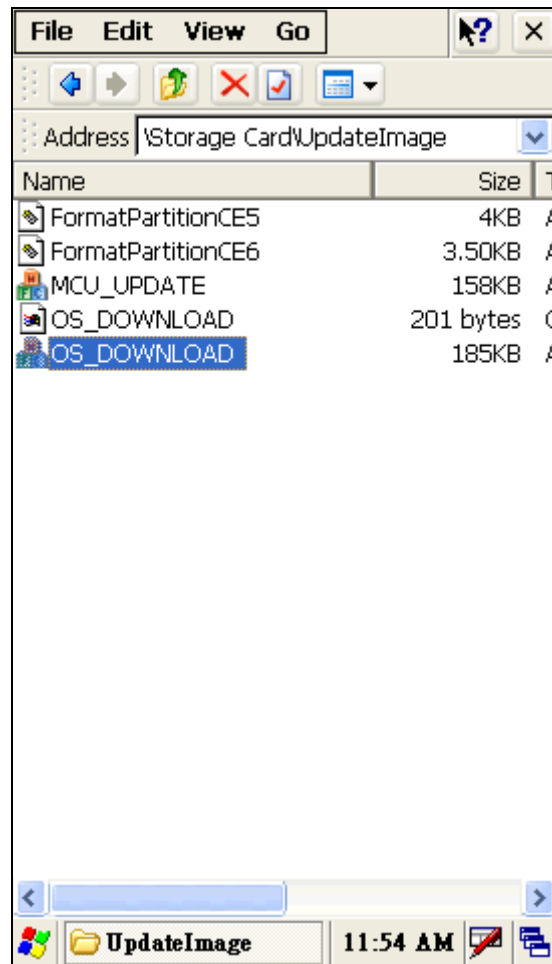

■ Update OS image

1. Check the settings of the "OS" tab on the OS-Download tool.
2. Click "**DOWNLOAD**" button to start OS image download procedure
3. Cold boot and reset the system to factory default mode after download procedure completed

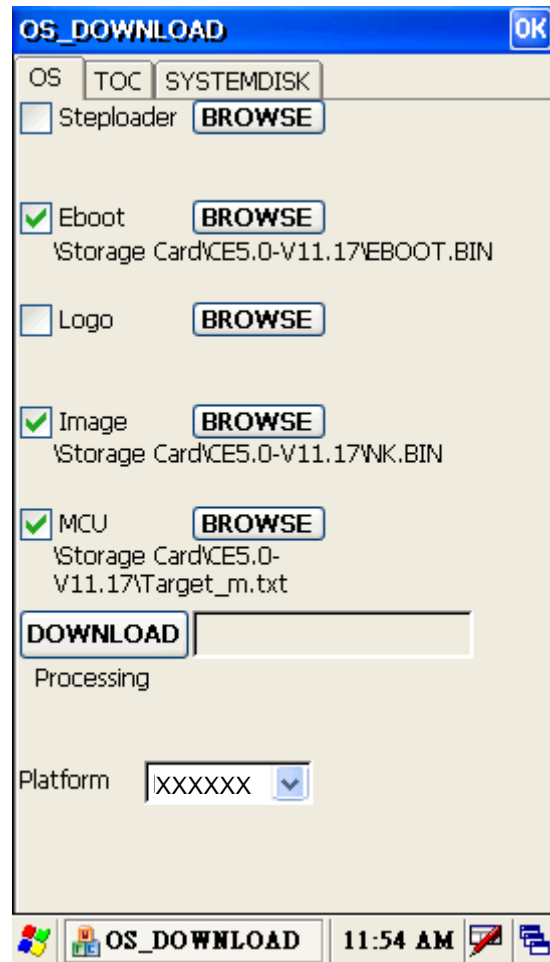

4

Application Programming Interface

4-1 Windows Embedded CE 5.0 Standard

Interface Introduction

Most of the software programming interfaces of the device are as follows.

- **Core OS Service**
(<http://msdn.microsoft.com/en-us/library/aa450512.aspx>)
- **Kernel**
(<http://msdn.microsoft.com/en-us/library/aa450998.aspx>)

Programming interface of RAM file system

- **File system and storage management**
(<http://msdn.microsoft.com/en-us/library/ms892386.aspx>)

Programming interface of Persistent storage

- **Folder name: "Backup"**
- **Block Drivers**
(<http://msdn.microsoft.com/en-us/library/ms923712.aspx>)
- **File system and storage management**
(<http://msdn.microsoft.com/en-us/library/ms892386.aspx>)

Programming interface of Secure Digital Card

- **Folder name: "Storage Card"**
- **Secure Digital Card Drivers**
(<http://msdn.microsoft.com/en-us/library/ms923739.aspx>)
- **Block Drivers**
(<http://msdn.microsoft.com/en-us/library/ms923712.aspx>)
- **File system and storage management**
(<http://msdn.microsoft.com/en-us/library/ms892386.aspx>)

Programming interface of Audio

- **Audio**
(<http://msdn.microsoft.com/en-us/library/ms890653.aspx>)
- **Audio Drivers**
(<http://msdn.microsoft.com/en-us/library/aa910103.aspx>)

Programming interface of Display(LCD)

- **Shell and User Interface**
(<http://msdn.microsoft.com/en-us/library/aa453940.aspx>)
- **Graphic**
(<http://msdn.microsoft.com/en-us/library/ms923392.aspx>)
- **Display Drivers**
(<http://msdn.microsoft.com/en-us/library/aa447505.aspx>)

Programming interface of USB Host

- **USB Host Drivers**
(<http://msdn.microsoft.com/en-us/library/ms923751.aspx>)
- **Shell, GWES, and User Interface**
(<http://msdn.microsoft.com/en-us/library/aa932172.aspx>)

Programming interface of MSR Reader

Programming interface of USB Slave

- **USB Function Drivers**
(<http://msdn.microsoft.com/en-us/library/aa931533.aspx>)
- **USB Serial Host Driver (Activesync)**
(<http://msdn.microsoft.com/en-us/library/aa932783.aspx>)
- **File system and storage management (Card Reader)**
(<http://msdn.microsoft.com/en-us/library/aa914412.aspx>)

Programming interface of Wireless

- **Network Driver**
(<http://msdn.microsoft.com/en-us/library/aa919639.aspx>)
- **Networking - Core**
(<http://msdn.microsoft.com/en-us/library/aa917156.aspx>)
- **Networking - Remote**
(<http://msdn.microsoft.com/en-us/library/aa920180.aspx>)
- **Networking – Wireless (Wi-Fi)**
(<http://msdn.microsoft.com/en-us/library/aa916578.aspx>)

Programming interface of Touch

- **Touch Screen Drivers**
(<http://msdn.microsoft.com/en-us/library/aa925927.aspx>)
- **Shell, GWES, and User Interface**
(<http://msdn.microsoft.com/en-us/library/aa932172.aspx>)

Programming interface of Button

- **Keyboard Drivers**
(<http://msdn.microsoft.com/en-us/library/aa932012.aspx>)
- **Shell, GWES, and User Interface**
(<http://msdn.microsoft.com/en-us/library/aa932172.aspx>)

Programming interface of Vibrator

- **Notification LED Drivers**
(<http://msdn.microsoft.com/en-us/library/aa925927.aspx>)
- **Shell, GWES, and User Interface**
(<http://msdn.microsoft.com/en-us/library/aa932172.aspx>)

Programming interface of System Power

- **Battery Drivers (Battery)**
(<http://msdn.microsoft.com/en-us/library/aa932396.aspx>)
- **Power Management (Power status – battery/DC)**
(<http://msdn.microsoft.com/en-us/library/aa923906.aspx>)

Programming interface of Power Management

- **Power Management**
(<http://msdn.microsoft.com/en-us/library/aa923906.aspx>)

4-2 Non WindowsCE Standard

4-2-1 Admin/User Mode Application

Architecture Introduction:

System provides three pair of directories to map the working folder of each operating mode.

Working folders name of Admin mode

/Windows/Desktop

File folder for saving the shortcut of application program in the Desktop.

/Windows/Programs

File folder for saving the shortcut of application program in the Programs tab at start menu.

/Windows/StartUp

File folder for saving the shortcut of application program in the StartUp folder where to be used to auto-run the programs during OS booting phase .

Working folders name of User mode

/Windows/Desktop_

File folder for saving the shortcut of application program in the Desktop.

/Windows/Programs_

File folder for saving the shortcut of application program in the Programs tab at start menu.

/Windows/StartUp_

File folder for saving the shortcut of application program in the StartUp folder where to be used to auto-run the programs during OS booting phase.

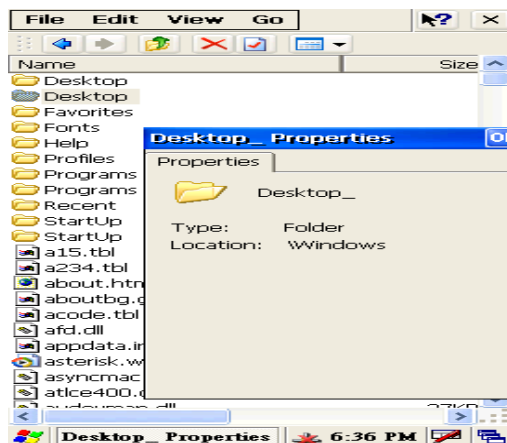

Switching between Admin mode and User mode

There is a control box in the control panel applet, -"Password" The default password is "1111".

Step:

1. Find Password control box from control panel applet.
2. Enter password: "1111" (Default)
3. Select User mode or Admin mode.
4. Type the "OK" button of password properties control box.
5. Type the "OK" button of "Mode Chang" dialog for double confirmation.
6. System would reboot automatically to the selected mode.

How to use this feature?

System integrators only have to copy the desired files to the working folders of each mode.

It is impossible to change the operation mode by resetting the system to factory defaults.

In case the user forget the password. The only way to retrieve the password is to run the Manufacturer maintenance application by copying the application to a SD card and cold resting the device.

Step:

1. Copy the desired files to the working folder of the operation mode
2. Follow Section "Switch the operation mode between Admin mode and User mode" to switch operation mode.

4-2-2 Overwrite Factory Default

Architecture Introduction:

The Manufacturer provides a mechanism to merge the OEM application and OEM specific settings into WindowCE operating system during booting phase. This feature can make OEM stuffs as system default components. There are many benefits for device maintenance.

It is a valuable feature for OEM doesn't have to reinstall OEM programs after end user reset the device to factory default mode. This benefit also helps to reduce the RMA cost from OEM vender.

Because of this system architecture, WindowCE operating system and OEM application programs are not merged together. So both parts can be upgraded separately.

Architecture of the OEM Device Manager

System Integrator should base on the directory structure of WindowCE to prepare the OEM installation files in SD card. All files in "GHARST" file directory would be copy into WindowCE file system during cold booting phase. By the way, the config files in "configfiles" directory are for system registry maintenance.

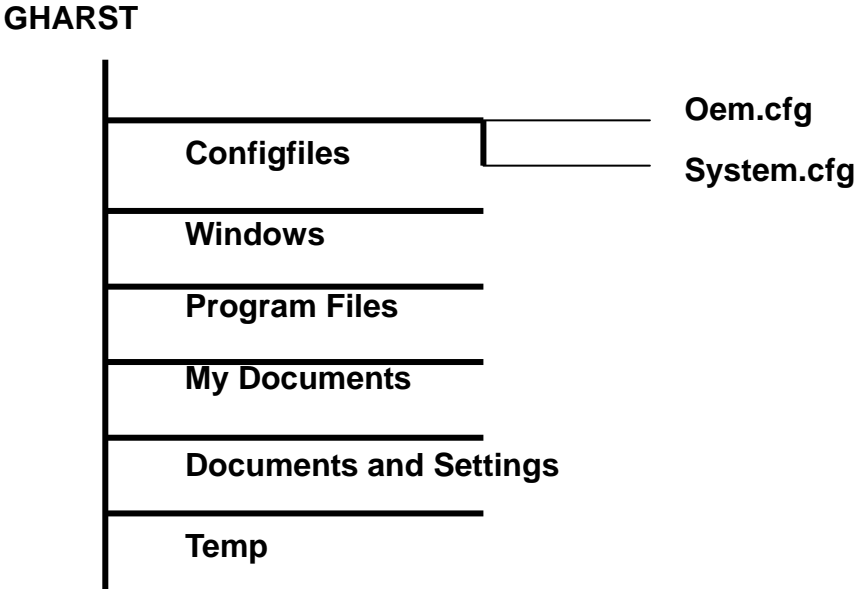

Merge an application program into default operating system by using the OEM Device Manager

◆ Example:

– For Auto-running the OEM application at booting phase of user mode when after reset to factory default.

1. Create a file directory “GHARST” in root folder of SD card.
2. Change into “GHART” folder to create directory “Windows”.
3. Change into “Windows” folder to create directory “StartUp_”.
4. Copy the OEM application file into “Windows->StartUp_” folder.
[Second way is: copy OEM application file into “Windows” folder, creates a lnk file of OEM application and copy it into “Windows->StartUp_” folder.]
5. Put SD card into the SD socket on the device.
6. Use OEM The device Manager to merge all files in “GHARST” folder in SD card into the device. After the file integration process, all OEM specify files will be the system default components of the device.

– Place the OEM application at “Programs” folder in Windows Start menu - System running in user mode.

1. Create a file directory “GHARST” in root folder of SD card.
2. Change into “GHART” folder to create directory “Windows”.
3. Change into “Windows” folder to create directory “Programs_”.
4. Copy the OEM application file into “Windows->Programs_” folder.
[Second way is: copy OEM application file into “Windows” folder, creates a lnk file of OEM application and copy it into “Windows->Programs_” folder]
5. Put SD card into the SD socket on the device.
6. Use OEM The device Manager to merge all files in “GHARST” folder in SD card into the device. After the file integration process, all OEM specify files will be the system default components of the device.

How to overwrite the factory default settings by using the OEM Device Manager

Two config files are used to modify the registry settings of factory default mode. System Integrator is easy to add and/or modify the registry key without upgraded the image of WindowsCE operating system. The way to

remove the registry key is to put empty to the key value in the config file.
System.cfg – Using for early registry initialization stage at booting phase.
Oem.cfg – Using for system registry initialization stage at booting phase.

◆ **Example:**

– **Overwrite the factory default backlight level setting.**

1. Create a file directory “GHARST” in root folder of SD card.
2. Change into “GHART” folder to create directory “configfiles”.
3. Prepare the oem.cfg config file by text editor.

Input following setting:

```
[HKEY_CURRENT_USER\ControlPanel\BackLight]
    "BatteryBacklightLevel"=dword:7
    "ACBacklightLevel"=dword:A
```

4. Copy oem.cfg file into “configfiles” folder.
5. Put SD card into the SD socket on device.
6. Use OEM Device Manager to merge all files in “GHARST” folder in SD card into device. After the integration process, all OEM desired settings will be the system default settings of device.

– **Overwrite the default WiFi state to power on mode. (Default is power down)**

1. Create a file directory “GHARST” in root folder of SD card.
2. Change into “GHART” folder to create directory “configfiles”.
3. Prepare or modify the oem.cfg config file by text editor.

Input following setting:

```
[-HKEY_LOCAL_MACHINE\Comm\NdisPower]
```

4. Store oem.cfg file into “configfiles” folder.
5. Put SD card into the SD socket on device.
6. Use the OEM device manager to merge all files in “GHARST” folder in SD card into device. After the integration process, all OEM desired settings will be the system default settings of device.

– **Remove a registry key from the registry in factory default settings**

Set the key to empty. Factory manager will remove the specific key from the default system registry.

Example:

```
[HKEY_LOCAL_MACHINE\RegistryKey]
    "ValueName"=
```

Overwrite Factory Default Registry Settings for OEM Customization (oem.cfg)

<1> Bluetooth operating mode

[HKEY_LOCAL_MACHINE\System\State\Hardware\Bluetooth]

"BluetoothOn"=dword:1 ; 1-> BT on, 0->BT off

"BluetoothWakeUpEnable"=dword:0 ;1-> Enable, 0-> Disable

<2> WiFi operating mode is off

[HKEY_LOCAL_MACHINE\Comm\NdisPower]

"GSPI86861"=dword:4 ; 4->WiFi off

WiFi operating mode is on

[-HKEY_LOCAL_MACHINE\Comm\NdisPower]

[HKEY_LOCAL_MACHINE\Comm\GSPI86861\Parms]

"PowerMode" = dword:1 ; 0: Performance mode, 1: PS mode

"MultipleDTim"=dowrd:2 ; PS mode (0,1,2,3,4 –most power saving)

<3> Screen rotation feature

[HKEY_LOCAL_MACHINE\System\GDI\Rotation]

"Angle"=dword:1 ;(Decimal 0->0 degree, 90->90 degree, 180->180 degree, 270->270 degree) // Manual rotate mode

"AutoRotate"=dword:F // Auto Rotate control

; bit 15 = 0 (Manual rotate) = 1 (Auto Rotate)

; bit 0 = 0 (180 degree ignored) = 1 (180 degree accepted)

; bit 1 = 0 (90 degree ignored) = 1 (90 degree accepted)

; bit 2 = 0 (0 degree ignored) = 1 (0 degree accepted)

; bit 3 = 0 (270 degree ignored) = 1 (270 degree accepted)

<4> Backlight control

[HKEY_CURRENT_USER\ControlPanel\BackLight]

"BatteryBacklightLevel"=dword:7 // Backlight level of battery only

"ACBacklightLevel"=dword:A // Backlight level of AC IN mode

"BatteryTimeout"=dword:3c // Backlight timeout value of battery only mode

"ACTimeout"=dword:258 // Backlight timeout value of AC IN mode

"DimTimeOut"=dword:1E // Backlight DIM mode timeout

"UseBattery"=dword:0 // Battery only mode timeout
Enable/Disable
"UseExt"=dword:0 // AC IN mode timeout Enable/Disable
"UseDim"=dword:0 // Backlight DIM mode
Enable/Disable

<5> CPU operating frequency control

Option1: Dynamic Mode

[HKEY_LOCAL_MACHINE\Drivers\BuiltIn\IPM]

"ProfileType"=dword:0

Option2: Performance Mode

[HKEY_LOCAL_MACHINE\Drivers\BuiltIn\IPM]

"ProfileType"=dword:1

"Speed"=dword:0

Option3: Power Saving Mode

[HKEY_LOCAL_MACHINE\Drivers\BuiltIn\IPM]

"ProfileType"=dword:1

"Speed"=dword:4

Application program of the OEM Device Manager

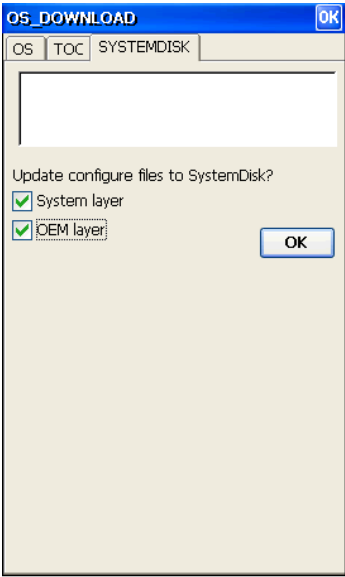

Snapshot of OEM Device Manager

System Layer : "system.cfg" file update

OEM Layer : "oem.cfg" file update

Press "OK" button to merge the GHARST directory and specified layer config files into OS image

Overwrite display backlight settings

Once the backlight is enabled, you can set both battery and AC power settings for the backlight. System Integrators can use the Control Panel to change the setting values or modify the following registry keys to change the settings. Note the units for the timeout values are in seconds.

Registry Key:

[HKEY_CURRENT_USER\ControlPanel\Backlight]

Modify display backlight settings for AC power

Values:

- UseExt : 1 (Enable/default) / 0 (Disable)
- ACTimeout : 15/30/60/120/300/600(default)/900/1800
- ACBacklightLevel : 0/1/2/3/4/5/6/7/8/9/10(default)

Modify display backlight settings for battery power

Values:

- UseBattery : 1 (Enable/default) / 0 (Disable)
- BatteryTimeout : 15/30/60(default)/120/300
- BatteryBacklightLevel : 0/1/2/3/4/5/6/7(default)/8/9/10

Modify display backlight settings for DIM mode

Values:

- UseDim : 1 (Enable/default) / 0 (Disable)
- DimTimeout : 15/30(default)/60/120/300

Example Code (Update backlight level)

```
void UpdateRegistry(DWORD dwVal)
{
    TCHAR szRegClass[] = TEXT("DWORD");
    HKEY hRegBacklight;
    DWORD dwDisposition;
    if(ERROR_SUCCESS ==
    RegCreateKeyEx(HKEY_CURRENT_USER, L"ControlPanel\\Backlight", 0,
    szRegClass, REG_OPTION_NON_VOLATILE, 0, NULL, &hRegBacklight,
    &dwDisposition))
    {
        LONG IResult;
        DWORD dwType = REG_DWORD;
```

```
DWORD    dwLen = sizeof(DWORD);

// Battery Level
IResult = RegSetValueEx(hRegBacklight,
L"BatteryBacklightLevel", 0, dwType, (LPBYTE)&dwVal, dwLen);

// AC Level
IResult = RegSetValueEx(hRegBacklight, L"AcBacklightLevel", 0,
dwType, (LPBYTE)&dwVal, dwLen);
    }
    RegCloseKey(hRegBacklight);
}
```

4-2-3 Vibration notification feature

This device is designed with a vibration motor for notification. The driver follows the LED driver architecture of WindowCE. This architecture uses WindowCE NLED standard API for application development.

Data Structure introduction

```
struct NLED_SETTINGS_INFO
{
    UINT    LedNum;
    INT     OffOnBlink;
    LONG    TotalCycleTime;
    LONG    OnTime;
    LONG    OffTime;
    INT     MetaCycleOn;
    INT     MetaCycleOff;
};
```

LedNum

LED number. Virbrator is zero (0).

OffOnBlink

Current setting. The following table shows the defined values.

Value	Description
0	Off
1	On
2	Blink

TotalCycleTime

Total cycle time of a blink, in microseconds. (Not support – default 0)

OnTime

On time of the cycle, in microseconds. (Not support – default 0)

OffTime

Off time of the cycle, in microseconds. (Not support – default 0)

MetaCycleOn

Number of on blink cycles. (Not support – default 0)

MetaCycleOff

Number of off blink cycles. (Not support – default 0)

Example code

```
#include "stdafx.h"

NLED_SETTINGS_INFO ledSettingsInfo = { 0 };

void SetVibratorOn(void)
{
    ledSettingsInfo.LedNum = 0;
    ledSettingsInfo.OffOnBlink = 0;
    if(!NLED_SetDevice(NLED_SETTINGS_INFO_ID,&ledSettingsInfo))
        MessageBox(L"NLED ghNLED = NULL!!",L"Error",MB_OK);
}
```