

# POSX

---

## ***XR520***

### Receipt Printer User's Manual

---





***Disposal of Old Electrical & Electronic Equipment (Applicable in the European Union and other European countries with separate collection systems)***

This symbol on the product or on its packaging indicates that this product shall not be treated as household waste. Instead it shall be handed over to the applicable collection point for the recycling of electrical and electronic equipment.

For more detailed information about recycling of this product, please contact your local city office, your household waste disposal service or the shop where you purchased the product.



---

---

**5-Year Limited Warranty**

**POS-X Inc. provides this five (5)-Year Warranty for this product.**

**For terms and conditions please go to:**

**[WWW.POS-X.COM](http://WWW.POS-X.COM)**

All specifications are subject to change without notice

## **TABLE OF CONTENTS**

1. Parts Identifications	3
2. Setting up the printer	4
2.1 Unpacking	4
2.2 Connecting the cables	5
2.3 Loading the Paper Roll	9
3. Control panel and other functions	12
4. Self Test	13
5. Hexadecimal Dump	14
6. Specifications	15
6.1. General Specifications	15
6.2. Auto Cutter Specifications	17
6.3. Interface	17
6.4. Electrical Characteristics	17
6.5. Environmental Requirements	18
6.6. Reliability	18
6.7. Certification	18
7. Command List	19

# 1. Parts Identifications

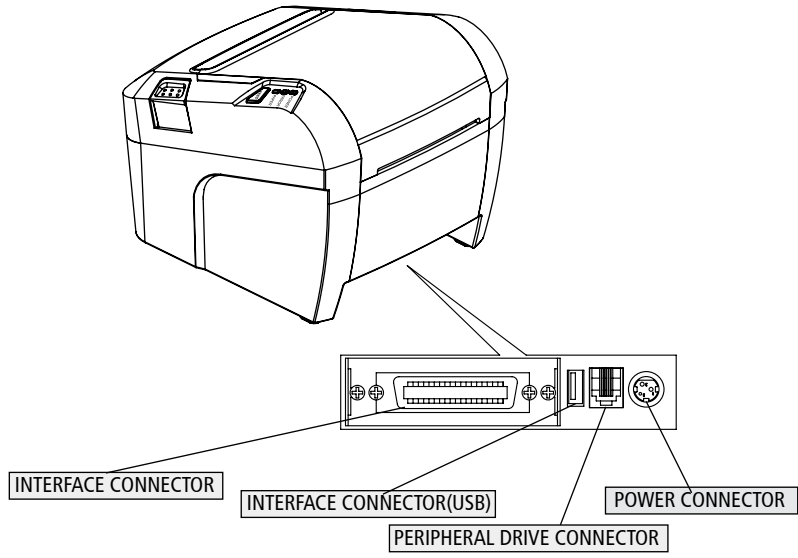
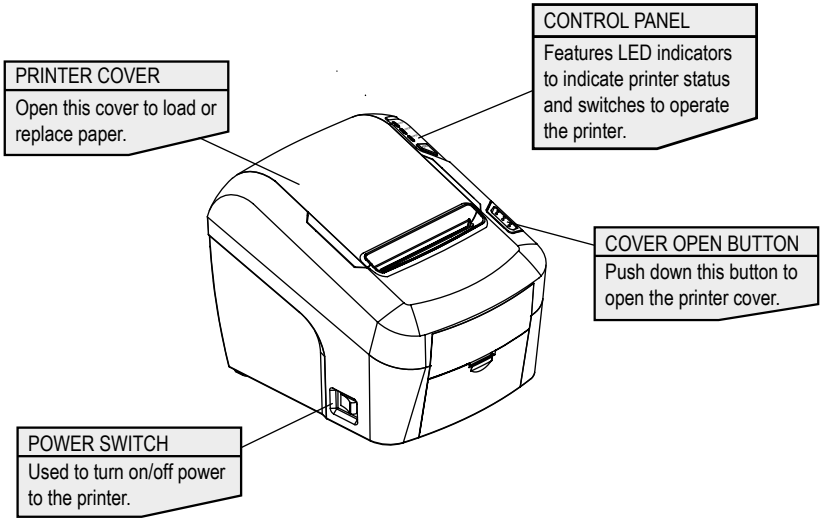

## 2. Setting Up the Printer

### 2-1. Unpacking

Your printer box should include these items. If any items are damaged or missing, please contact your dealer for assistance.

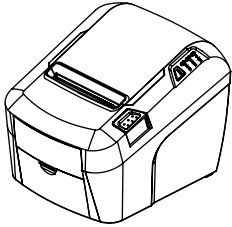

The Printer

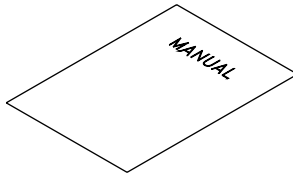

User's Manual

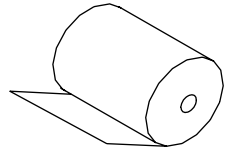

Paper Roll

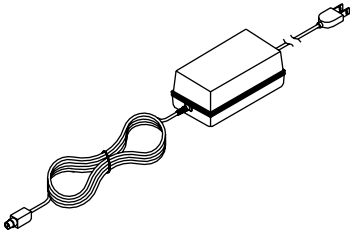

Power Adapter is included

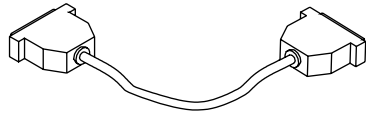

Interface Cable is included

## 2-2. Connecting the Cables

Please refer to the image below for the proper cable connection location

You can connect up the cables required for printing to the printer.

They all connect to the connector panel on the back of the printer, which is shown below :

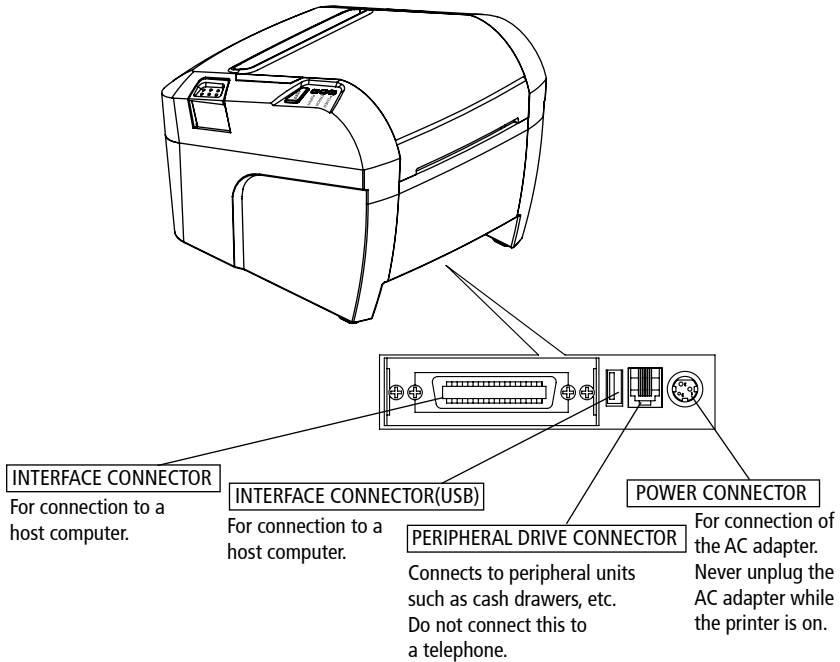

Before connecting any of the cables, make sure that both the printer and the computer are turned off.

## 2-2-1. Interface Connector

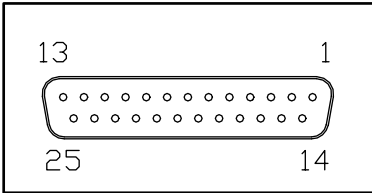

<D-SUB 25 Female Serial>

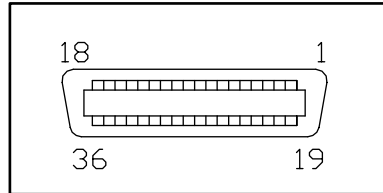

<Centronics Parallel>

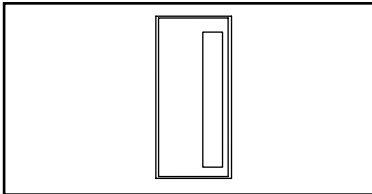

<USB "A" Type>

### Serial Interface

PIN	SIGNAL	I/O	DESCRIPTION
2	TXD	Output	Printer transmit data line RS-232C level
3	RXD	Input	Printer receive data line RS-232C level
4, 20	DTR	Output	Printer handshake to host line RS-232C level
6	DSR	Input	Data Send Ready
1, 7	GND	-	System Ground

### USB Interface

PIN	SIGNAL	I/O	DESCRIPTION
1	+5V	-	+5V
2	DATA-	-	Printer transmit data line
3	DATA+	-	Printer transmit data line
4	GND	-	System Ground

**Centronics Parallel Interface**

PIN	SIGNAL	I/O	DESCRIPTION
1	STROBE-	Input	Synchronize signal Data received
2~9	DATA0~7	Input/Output	Data bit Transmitted 0~7
10	ACK-	Output	Data receiving completed.
11	BUSY	Output	Impossible to print of data receiving.
12	PE	Output	Paper empty
13	SELECT	Output	Printer status for ON/OFF line
14	AUTO FEED-	Input	Paper auto feed signal
15	GROUND	-	System ground
16	GROUND	-	System ground
17	NC	-	
18	LOGIC-H	-	+3.3V
19~30	GROUND	-	System ground
31	INIT-	Input	Initialize
32	ERROR-	Output	Printer error
33	GROUND	-	System ground
34	NC	-	
35	NC	-	
36	SELLECT IN-	Input	Printer select signal

## 2-2-2. Cash Drawer Connector

The printer can operate two cash drawers with a 6 pin RJ-11 modular connector.

The driver is capable of supplying a maximum current of 1.0A/24VDC for 510ms or less when not printing.

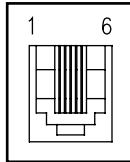

PIN	SIGNAL	DESCRIPTION
1	Signal GND	-
2	Drawer kick-out drive signal 1	Output
3	Drawer open/close signal	Input
4	+24V	-
5	Drawer kick-out drive signal 2	Output
6	Signal GND	-

Caution : To avoid an overcurrent, the resistance of the drawer kick-out solenoid must be 24  $\Omega$  or more.

## 2-3. Loading the Paper Roll

Notes: Be sure to use paper rolls that meet the specifications. Do not use paper rolls that have the paper glued to the core because the printer cannot detect the paper end correctly. (Turn off power switch)

1. Make sure that the printer is not receiving data; Otherwise, data may be lost.
2. Open the top cover unit by pushing down the cover open button.

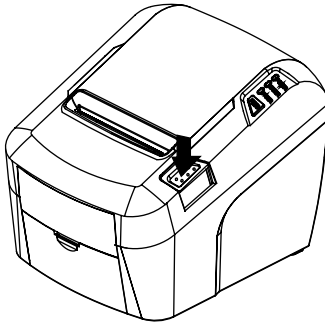

3. Remove the used paper roll core if there is one inside.
4. Insert new paper roll as shown.

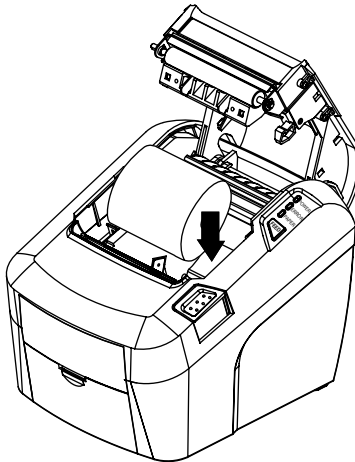

# XR520 User's Manual

---

5. Be sure to note the correct direction that the paper comes off the roll.

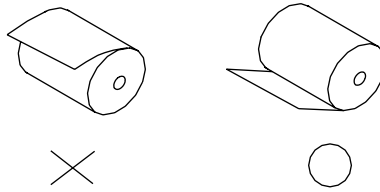

6. Pull out a small amount of paper, as shown. Then, close the cover.

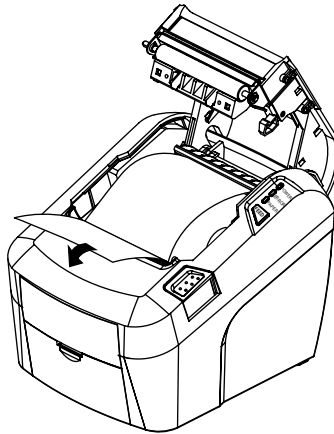

7. Tear off the paper as shown.

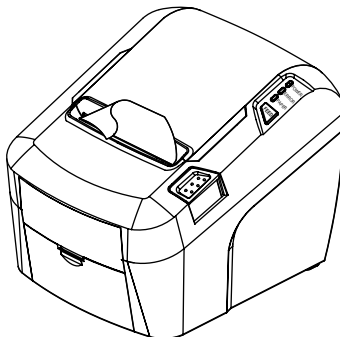

## ♣CAUTION:

When paper jam occurs the top cover might be stuck.

In this case, repeat power on and off several times.

If the top cover is still stuck, please follow the steps to release the papers from jamming.

1. Make sure the printer is turned off.
2. Take out cutter cover as shown.

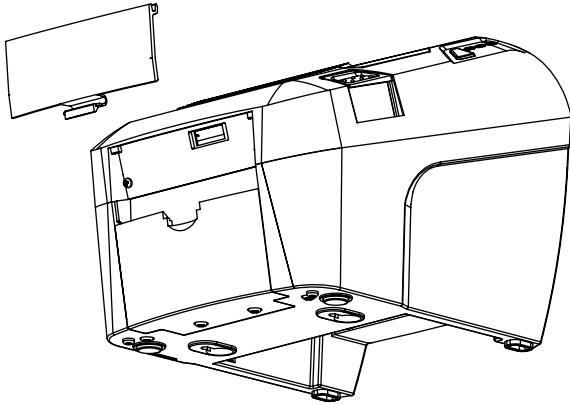

3. Turn screw with drivers to a direction until paper is released from the cutter.

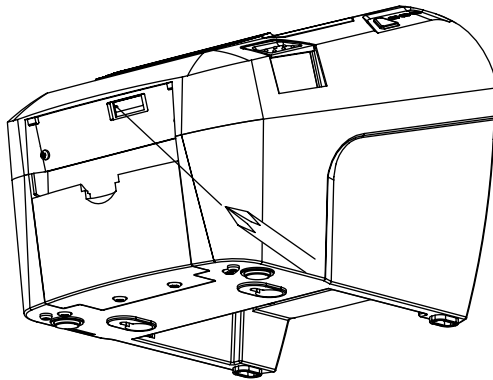

## 3. Control panel and other functions.

### 3-1. Control panel

You can control the basic paper feeding operations of the printer with the button on the control panel. The indicator lights help you to monitor the printer's status.

#### Control Panel

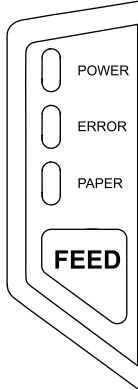

#### Button

The button can be disabled by the ESC c 5 command.

Press the FEED button once to advance paper one line. You can also hold down the FEED button to feed paper continuously.

### 3-2. Error indicators

This section explains the different patterns signaled by the three LED indicators located on the top cover of the printer.

STATUS	PAPER	ERROR	POWER	REMARKS
	RED	RED	GREEN	
Power off	OFF	OFF	OFF	Normal power is not supplied to the printer
Power on	OFF	OFF	ON	Normal power is supplied to the printer
On line	OFF	OFF	ON	Normal error-free mode
Cover open	OFF	ON	ON	Close cover
Paper empty	OFF	ON	ON	Insert new paper roll
Paper near end	ON	OFF	ON	Paper is low
Test mode	OFF	OFF	ON	Ignored error led

## 4. Self Test

The self-test lets you know if your printer is operating properly. It checks the control circuits, printer mechanisms, print quality, ROM version and DIP switch settings.

This test is independent of any other equipment or software.

### Running the self test

1. Make sure the printer is turned off and the printer cover is closed properly.
2. While holding down the FEED button, turn on the printer using the switch on the front of the printer to begin the self-test. The Self Test prints the printer settings and then prints the following, Cuts the paper, and pauses. (Error LED On)

### **Self-test printing**

**Please press the PAPER FEED button.**

3. Press the FEED button to continue printing.  
The printer prints a pattern using the built-in character set.
4. The self test automatically ends and cuts the paper after printing the following.

**\*\*\* Completed \*\*\***

The printer is ready to receive data as soon as it completes the self-test.

## 5. Hexadecimal Dump

This feature allows experienced users to see exactly what data is coming to the printer. This can be useful in finding software problems.

When you turn on the hex dump function, the printer prints all commands and other data in hexadecimal format along with a guide section to help you find specific commands.

### To use the hex dump feature, follow these steps

1. After you make sure that the printer is off and Dip s/w 1-2 is ON, turn on the printer.
2. Run any software program that sends data to the printer. The printer prints "Hexadecimal Dump" and then all the codes it receives in a two-column format. The first column contains the hexadecimal codes and the second column gives the ASC II characters that correspond to the codes.

### Hexadecimal Dump

1B 21 00 1B 26 02 40 40 !..& . @@

1B 25 01 1B 63 34 00 1B .%.. c4 ..

41 42 43 44 45 46 47 48 ABCDEFGH

A period (.) is printed for each code that has no ASC II equivalent.

3. Turn off the printer, and make sure that Dip sw 1-2 off.
4. Turn on the printer.

## 6. Specifications

### Appendix A : Specifications

#### 6-1. General Specifications

- (1) Printing Method                      Direct line thermal printing.
- (2) Print speed                            300mm/sec. (Approx 35.4LPS)
- (3) Dot density

180 DPI (Hor / Ver)	180 / 180 (0.141mm / 0.141mm dot)
---------------------	-----------------------------------

- (4) Printing Width

180 DPI	Max 72mm (512 dots)
---------	---------------------

- (5) Number of print columns.  
No. of columns

	Font "A"	Font "B"
180 DPI	42	56

- (6) Roll paper                              Refer to chapter 2 for details on the recommended roll Paper.  
Paper width : 50mm~80mm  
Roll diameter : Max. Ø80mm  
Thermal Paper type : NTP080-80
- (7) Weight                                    1.7Kg

## (8) Overall dimension

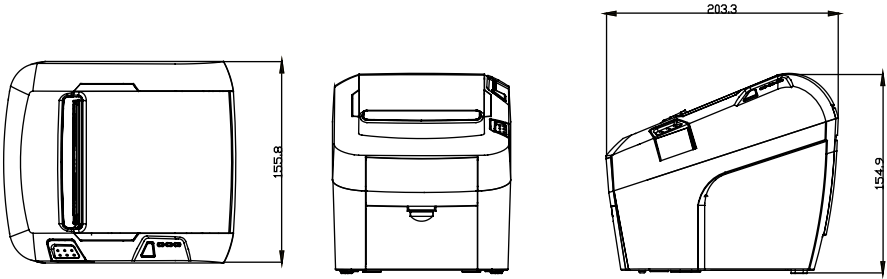

### 6-2. Auto Cutter Specifications

- (1) Cutting Frequency      Max. 30 cuts per minute
- (2) Thickness of paper      0.065 ~ 0.09 mm
- (3) Cutter Life              1.5 million cuttings  
                                         (if the paper thickness is between 65 and 90µm)

### 6-3. Interface

RS232C Serial Interface, Centronics Parallel Interface(IEEE1284), USB Interface  
USB COMBO Interface, Ethernet Interface(10Mbps)

### 6-4. Electrical Characteristics

- (1) Input Voltage              DC 24V ± 10%
- (2) Current Consumption      Operating: Approx. 1.5 A (at ASC II printing)  
                                         Peak : Approx. 10 A  
                                         (at print duty 100%, For 10 seconds or less)  
                                         Stand-by : Approx. 0.15 A
- (3) Power Connector

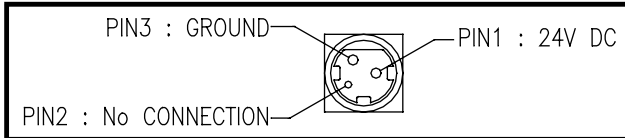

## ♣ Important!

When connecting or disconnecting the power supply from the printer, be sure that the following cautions are observed.

- (1) Use a power supply (Limited Power Supply) of DC 24V±10% and more than 2.5A.
- (2) Be careful about installing the printer in an area where there is noise.
- (3) Take the appropriate measure to protect against electrostatic AC line noise, etc.

## 6-5. Environmental Requirements

(1) Operating

Temperature 5°C to 40°C

Humidity 10% to 90% RH (without condensation)

(2) Transport/Storage (except paper)

Temperature -20°C to 60°C

Humidity 10% to 90% RH (without condensation)

## 6-6. Reliability

(1) MCBF 60 million lines (based on an average printing rate of 12.5% with paper thickness in the range of from 65µm - 75µm)  
35 million lines (based on an average printing rate of 12.5% with paper thickness in the range of from 76µm - 150µm)

(2) Head Life 160Km

(3) Cutter Life 1.5 million cuttings (if the paper thickness is between 65 and 90µm)

## 6-7. Certification

(1) FCC PART15 CLASS A

(2) CE EMCD/LVD

(3) UL/cUL

## 7. Command List

No.	Command	Function	REMARKS
1	HT	Horizontal tab	
2	LF	Print and line feed	
3	CR	Print and carriage return	
4	FF	Print and return to standard mode(in page mode)	
5	CAN	Cancel print data in page mode	
6	DLE EOT	Real-time status transmission	
7	DLE ENQ	Real-time request to printer	
8	DLE DC4	Generate pulse at real-time	
9	ESC FF	Print data in page mode	
10	ESC SP	Set right-side character spacing	
11	ESC !	Select print mode(s)	
12	ESC \$	Set absolute print position	
13	ESC %	Select/cancel user-defined character set	
14	ESC &	Define user-defined characters	
15	ESC *	Set bit-image mode	
16	ESC -	Turn underline mode on/off	
17	ESC 2	Select default line spacing	
18	ESC 3	Set line spacing	
19	ESC =	Select peripheral device	
20	ESC ?	Cancel user-defined characters	
21	ESC @	Initialize printer	
22	ESC D	Set horizontal tab positions	
23	ESC E	Turn emphasized mode on/off	
24	ESC G	Turn double-strike mode on/off	
25	ESC J	Print and feed paper using minimum units	
26	ESC L	Select page mode	
27	ESC M	Select character font	
28	ESC R	Select an international character set	
29	ESC S	Select standard mode	
30	ESC T	Select print direction in page mode	
31	ESC V	Turn 90° clockwise rotation mode on/off	
32	ESC W	Set printing area in page mode	
33	ESC \	Set relative print position	
34	ESC a	Select justification	
35	ESC c 3	Select paper sensor(s) to output paper-end signals	
36	ESC c 4	Select paper sensor(s) to stop printing	
37	ESC c 5	Enable/disable panel buttons	
38	ESC d	Print and feed paper <i>n</i> lines	
39	ESC p	General pulse	
40	ESC t	Select character code table	

# XR520 User's Manual

---

No.	Command	Function	REMARKS
41	ESC {	Turn upside-down printing mode on/off	
42	FS p	Print NV bit image	
43	FS q	Define NV bit image	
44	GS !	Select character size	
45	GS \$	Set absolute vertical print position in page mode	
46	GS *	Define downloaded bit image	
47	GS /	Print downloaded bit image	
48	GS B	Turn white/black reverse printing mode on/off	
49	GS H	Select printing position of HRI characters	
50	GS I	Transmit printer ID	
51	GS L	Set left margin	
52	GS P	Set horizontal and vertical motion units	
53	GS V	Select cut mode and cut paper	
54	GS W	Set printing area width	
55	GS \	Set relative vertical print position in page mode	
56	GS a	Enable/disable Automatic Status Back(ASB)	
57	GS f	Select font for HRI characters	
58	GS h	Set bar code height	
59	GS k	Print bar code	
60	GS r	Transmit status	
61	GS v 0	Print raster bit image	
62	GS w	Set bar code width	
	< Add >		
1	ESC i	Full cut	
2	ESC m	Partial cut	
3	FS !	Set print mode(s) for Kanji characters	
4	FS &	Select Kanji character mode	
5	FS -	Turn underline mode on/off for Kanji character	
6	FS .	Cancel Kanji character mode	
7	FS 2 c1 d1...dk	Define user-defined Kanji characters	
8	FS C	Select Kanji character code system	
9	FS S 1 2	Set Kanji character spacing	
10	FS W	Turn quadruple-size mode on/off for Kanji character	





**POS-X, Inc.**

1975 Midway Lane Suite O  
Bellingham WA 98226  
360-738-8433  
support@pos-x.com

*Rev. 1.0*